

Archaeological Evaluation on Land at Tanyard Farm, Lenham, Kent

Site Code: LEN-EV-18

NGR: NGR Site Centre: 590398 152149

Planning Application Number: 17/500357/HYBRID



Report for ROGATE

18/08/2018

V01

SWAT ARCHAEOLOGY

Swale and Thames Archaeological Survey Company

The Office, School Farm Oast, Graveney Road

Faversham, Kent ME13 8UP

Tel; 01795 532548 or 07885 700 112

info@swatarchaeology.co.uk www.swatarchaeology.co.uk

© SWAT Archaeology 2018 all rights reserved

Archaeological Evaluation on Land at Tanyard Farm, Lenham, Kent

1	INTRODUCTION	8
1.1	Project Background	8
1.2	Timetable	9
1.3	Site Description and Topography.....	9
2	ARCHAEOLOGICAL AND HISTORICAL BACKGROUND.....	9
2.1	Introduction	9
2.2	Previous Archaeological Investigations on Site.....	11
3	AIMS AND OBJECTIVES.....	11
3.1	Specific Aims (SWAT 2018)	11
3.2	General Aims	12
4	METHODOLOGY.....	12
4.1	Introduction	12
4.2	Fieldwork.....	12
4.3	Recording	13
5	RESULTS	13
5.1	Introduction	13
5.2	Stratigraphic Deposit Sequence	13
5.3	Archaeological Narrative.....	14
	<i>Negative trenches</i>	14
	<i>Trench 1 (Figure 5, Plates 2-5)</i>	14
	<i>Trench 2 (Figure 6, Plates 6-28)</i>	14
	<i>Trench 3 (Figure 7, Plate 29)</i>	15
	<i>Trench 4 (Figure 8, Plates 30-32)</i>	15
	<i>Trench 5 (Figure 9, Plates 33-35)</i>	16
	<i>Trench 7 (Figure 11, Plates 38-40)</i>	16
	<i>Trench 10 (Figure 12, Plate 43)</i>	16

	<i>Trench 11 (Figure 13, Plates 44-47)</i>	17
	<i>Trench 13 (Figure 14, Plate 48)</i>	17
	<i>Trench 14 (Figure 15, Plate 48)</i>	17
	<i>Trench 15</i>	18
6	FINDS	18
6.1	Quantification of Archaeological Material.....	18
7	DISCUSSION	20
7.1	Introduction	20
7.2	Archaeological Narrative.....	20
7.3	Recommendations	21
7.4	Conclusions	22
8	ARCHIVE	22
8.1	General.....	22
9	ACKNOWLEDGMENTS	22
10	REFERENCES	23
11	APPENDIX 1 – TRENCH TABLES	24
12	APPENDIX 2 – HER FORM	34
13	APPENDIX 3 – GEOPHYSICAL SURVEY REPORT (SUMO 2018)	35

Tables

Table 1	Timetable for the archaeological programme of works	9
Table 2	Quantification of the Archaeological Material	19

Figures

Figure 1	Site location plan
Figure 2	Evaluation Trench Location – Phase 1
Figure 3	Evaluation Trench Plan in relation for proposed development
Figure 4	Evaluation Trench Plan in relation to geophysical survey
Figure 5	Trench 1
Figure 6	Trench 2

Figure 7	Trench 3
Figure 8	Trench 4
Figure 9	Trench 5
Figure 10	Trench 6
Figure 11	Trench 7
Figure 12	Trench 10
Figure 13	Trench 11
Figure 14	Trench 12
Figure 15	Trench 14
Figure 16	Trench 21
Figure 17	Sections
Figure 18	Sections
Figure 19	Sections

Plates

Plate 1:	Looking north east at the site from south east corner
Plate 2:	Looking west north-west at Trench 1
Plate 3:	Looking South at section of Trench 1. Modern trench is visible under right end of 2m scale. To the left test pit dug to bedrock level.
Plate 4:	Looking east-south-east at Roman pit [105]
Plate 5:	Looking south-south-west at section through Roman pit [105]
Plate 6:	Looking north-north-east at Trench 2
Plate 7:	Looking east-south-east at extension B of Trench 2. At the end of trench a backfilled test pit is visible.
Plate 8:	Looking west at Extension C of Trench 2.
Plate 9:	Looking north at edge of Roman layer (204) exposed in test pit located at east end of extension C of Trench 2
Plate 10:	Looking west at section through edge of Roman layer (204) exposed in test pit
Plate 11:	Looking north-north-east at section of extension B of Trench 2
Plate 12:	Looking north-north-east at floor (219)
Plate 13:	Looking east at section of post hole [216] and post pack boulders (218)
Plate 14:	Looking west-north-west at section of trench 2 through deposits overlaying floor (219)
Plate 15:	Looking east at post hole [205] prior excavation.
Plate 16:	Looking north east at section through post hole [205]
Plate 17:	Looking north-north-east at section through post hole [207]
Plate 18:	Looking north east at section through post hole [212]

- Plate 19: Looking north east at section through post hole [214].
- Plate 20: Looking north-east at row of post holes [214, 212, 207, 205]
- Plate 21: Looking south west at row of post holes exposed in Trench 2
- Plate 22: Looking north east at stone deposit (224)
- Plate 23: Looking south west at stone deposit (209)
- Plate 24: Looking north- north- east at stone deposit (222)
- Plate 25: Looking west-north-west at Roman trample layer (223) located to the south from context (222).
- Plate 26: Looking north-north-east at stone deposit (220)
- Plate 27: Looking west-north-west at section of trench 2 through deposits overlaying stone bank (221)
- Plate 28: Looking west-north-west at section of northern end of Trench 2. Visible here top soil, sub soil and natural.
- Plate 29: Looking west-north-west at Trench 3 with bedrock and orange-brown silty clay exposed.
- Plate 30: Looking east-south-east at trench 4. Edge of SE-NW Roman ditch is visible in bottom right trench corner, another parallel Roman ditch is located underneath two metres scale.
- Plate 31: Looking south east at section through Roman ditch [404] exposed in Trench 4. Above the section a darker fill of Roman ditch, is visible running NE-SW across the trench
- Plate 32: Looking south east at section through Roman ditch [404]
- Plate 33: Looking north-north-east at Trench 5. Undulating chalk bedrock and periglacial deposit exposed at the bottom of the trench
- Plate 34: Looking north east at section through Trench 5 showing drop of level of chalk bedrock
- Plate 35: Looking east-south-east at section through Roman ditch [504]
- Plate 36: Looking east-south-east at Trench 6
- Plate 37: Looking north-north-east at section of Trench 6. Bright linear visible under right end of two metre scale is a modern service trench also exposed in Trench 1.
- Plate 38: Looking north-north-east at trench 7 with Roman ditch exposed
- Plate 39: Looking north-north-east section through Roman ditch [704].
- Plate 40: Looking west-north-west at section of Trench 7 through top soil, sub soil and top of chalk bedrock.
- Plate 41: Looking north-north-east at Trench 8
- Plate 42: Looking east-south-east at section of Trench 8
- Plate 43: Looking north-north-east at Roman ditch [1004]
- Plate 44: Looking south-west at Roman ditch [1104]
- Plate 45: Ditch [1104] viewed from the south
- Plate 46: Looking NNE at small fire pit [1108]
- Plate 47: Ditch [1104] viewed from the south

Plate 48: Looking NE at section through Roman ditch [1404]

Summary

Swale & Thames Survey Company (SWAT Archaeology) was commissioned by ROGART to undertake an archaeological evaluation on land at Tanyard Farm, Lenham, Kent. The archaeological programme was monitored by the Senior Archaeological Officer at Kent County Council.

The Archaeological Evaluation consisted of 29 trenches, which recorded a relatively common stratigraphic sequence comprising topsoil and subsoil overlying natural geology. The fieldwork commenced on the 30th July 2018, being completed on the 8th August 2018.

The archaeological evaluation has recorded the presence of a small enclosure dating to the late 3rd-4th century that has replaced a larger open field system that dates to the latter part of the 2nd century. An area within the southern extent of the site contains at least two floors, one on top of the other, that are formed around a series of structural post holes, in alignment, that were probably associated with a structure of some kind. The dating for the structure seems to favour late 2nd-3rd century so it is plausible to suggest a contemporary relationship with the open field system to the immediate north.

In the event that finished ground levels remain constant, the depth of impact associated with future development is likely to require the excavation of material exceeding 0.50m in depth. It has been therefore recommended that further archaeological mitigation is focussed on targeted areas of excavation which can be carried out as part of a planning condition. The nature and scope of any further archaeological mitigation will need to be determined in consultation with the Senior Archaeological Advisor at Kent County Council.

Archaeological Evaluation on Land at Tanyard Farm, Lenham, Kent

NGR Site Centre: 590398 152149
Site Code: LAN-EV-18

1 INTRODUCTION

1.1 Project Background

- 1.1.1 Swale & Thames Survey Company (SWAT Archaeology) were commissioned by ROGATE to undertake an archaeological evaluation on land at Tanyard Farm, Lenham, Kent (Figure 1). A planning application (17/500357/HYBRID) is currently under consideration for the development of 48 new dwellings with an outline application for a further 102 dwellings, the provision of open space, vehicular access and landscaping.
- 1.1.2 In mitigation of the potential impact that the development may have on the buried archaeological resource, and on recommendations provided by the Heritage Conservation Team at Kent County Council (KCC), Maidstone Borough Council (MBC) have requested that a pre-determination archaeological investigation of the proposed site is carried out, in order to inform the Archaeological Advisor and Planning Officer of any archaeological mitigation measure that may be required, in advance of a planning application. KCC requested that the programme of works consists of a geophysical survey followed by a targeted archaeological evaluation, in accordance with a specification agreed with KCC and MBC and should be undertaken prior to determination of the hybrid application (Wendy Rogers KCC 31st January 2018).
- 1.1.3 The geophysical survey was carried out by SUMO Survey in July 2018 and is summarised within this report (Section 2.2) with a copy being provided as Appendix 3.
- 1.1.4 The archaeological evaluation, which comprised the excavation of 29 trenches measuring 30m in length and 1.8m in width, was carried out between March 2018 and June 2018 (see Table 1 below) in accordance with an archaeological Written Scheme of Investigation (WSI) prepared by SWAT Archaeology (2018), prior to commencement of works.

1.2 Timetable

1.2.1 A timetable for the archaeological programme of works is provided below;

Task	Date	Personnel
Geophysical Survey	31 st July 2018	SUMO Survey
Submission of the Written Scheme of Investigation	24 th July 2018	Dr Paul Wilkinson
Archaeological trenching - start	30 th July 2018	Peter Cichy
Archaeological trenching - completion	8 th August 2018	Peter Cichy
Monitoring meeting with KCC	7 th August 2018	Wendy Rogers (KCC) and Peter Cichy

Table 1 *Timetable for the archaeological programme of works*

1.3 Site Description and Topography

1.3.1 The site is centred on NGR 590398 152149 and measures approximately 53,074m², situated immediately to the east of the village of Lenham on the south side of the Ashford Road/A20. It is bounded to the north by Ashford Road, to the south by Old Ashford Road, to the east by open land with properties to the south, and to the west by Groom Way with scattered buildings forming the outskirts of the village. A north-south orientated trackway/field boundary crosses the site (Figure 1).

1.3.2 The Geological Survey of Great Britain (1:50,000) shows that the site is set on Bedrock Geology of West Melbury Marley Chalk Formation. Superficial deposits are chalky subsoil topped by topsoil. The site is set at an average height of approximately 110m aOD (above Ordnance Datum) gently increasing to 115m aOD towards the north-east corner of the site.

2 ARCHAEOLOGICAL AND HISTORICAL BACKGROUND

2.1 Introduction

2.1.1 Further details of previous discoveries and investigations within the immediate and wider area may be found in the Kent County Council Historic Environment Record and have been summarised in the Archaeological Desk-based Assessment produced by Canterbury Archaeological Trust (CAT 2015).

2.1.2 The Archaeological Desk-based Assessment states the following;

'Evidence for activity dating to varying phases of the prehistoric period are recorded within and in the vicinity of the PDA. A concentration of Mesolithic flint artefacts found as surface finds is recorded from a field to the south-west at Court Farm, and this spread of material is known to extend into the

PDA. Evidence for activity relating to the Iron Age is more widespread, with scattered finds from the area including within the PDA, but there is stronger evidence of possible settlement activity further to the west and southeast. In view of this evidence the potential for prehistoric archaeological remains to be encountered within the PDA is considered to be moderate, with Iron Age remains most likely to be present. Should they be encountered remains of this date are likely to be of at least regional research significance, and the impact upon them brought about by the new development potentially high.

Evidence from archaeological investigation at Lenham Community Centre strongly indicates that linear features of Romano-British date recorded on the site are likely to extend within the PDA. This proven evidence for modification of the land during this period, combined with potential industrial activity to the south-west and the scattering of metal detector finds and other material across the area points to there being settlement activity of this date, as yet to be identified, close by. In view of this evidence the potential for Romano-British archaeological remains to be encountered within the PDA is considered to be high, with continuation of the linear features recorded to the west most likely to be encountered. Should Romano-British remains be present within the PDA, they are likely to be of at least regional research significance, and the impact upon them posed by the new development potentially high.

Although Anglo-Saxon activity is recorded in the vicinity of the PDA, remains of this date are most likely to be centred further to the west, within the core of the village itself. The potential for archaeological remains of Anglo-Saxon date to be encountered within the PDA is considered to be low to moderate, however, should such remains be present within the site, they are likely to be of at least regional research significance, relating to the little understood origins of the village, and the impact upon them posed by the new development potentially high.

Medieval activity within the PDA, should it be present, is most likely to relate to agricultural activity or land use rather than settlement, which similarly was more likely centred further west. The potential for archaeological remains of this date to be encountered within the PDA is considered to be low to moderate. Should such remains be present within the site, they are likely to be of regional research significance, relating to the little understood origins of the village, and the impact upon them posed by the new development potentially high.

There is little evidence that significant post-medieval or modern activity within the PDA. Disturbance relating to construction of the new A20/Ashford Road may be present towards the north of the site, however little else apart from features relating to recent agricultural use of the site is expected. The potential for post-medieval and modern archaeological remains to be encountered within the PDA

is considered to be low to moderate. Should significant remains be present within the site, they are likely to be of regional research significance, and the impact upon them posed by the new development potentially high.

Canterbury Archaeological Trust (2015: Section 6.2-6.4)

2.1.3 The Desk-based assessment concludes with the recommendation for an archaeological evaluation followed by appropriate mitigation measures (2015: 13).

2.2 Previous Archaeological Investigations on Site

2.2.1 A detailed geophysical survey, conducted by SUMO Survey, was carried out in July 2018. The magnetometry survey concluded that *'No definite archaeological anomalies have been identified, though possible ditch-type responses may be associated with the Romano-British site located immediately to the west. A modern track and evidence of ploughing are visible in the data, along with areas of natural magnetic variation and disturbance from nearby ferrous objects'* (2018:1).

2.2.2 A copy of the Geophysical Survey has been provided in Appendix 3.

3 AIMS AND OBJECTIVES

3.1 Specific Aims (SWAT 2018)

3.1.1 The specific aims of the archaeological fieldwork are set out in the Specification (SWAT 2018) as stated below;

'The primary objective of the archaeological evaluation is to establish or otherwise the presence of any potential archaeological features which may be impacted by the proposed development. The aims of this investigation are to determine the potential for archaeological activity and in particular the adjacent Roman remains and later archaeological activity.

The programme of archaeological work should be carried out in a phased approach and will commence with a geophysical survey and evaluation through trial trenching. This initial phase should determine whether any significant archaeological remains would be affected by the development and if so what mitigation measures are appropriate. Such measures may include further detailed archaeological excavation, or an archaeological watching brief during construction work or an engineering solution to any preservation in situ requirements'.

(SWAT Archaeology 2018: 6)

3.2 General Aims

3.2.1 The general aims of the archaeological fieldwork were to;

- establish the presence or absence of any elements of the archaeological resource, both artefacts and ecofacts of archaeological interest across the area of the development;
- ascertain the extent, depth below ground surface, depth of deposit if possible, character, date and quality of any such archaeological remains by limited sample excavation;
- determine the state of preservation and importance of the archaeological resource, if present, and to assess the past impacts on the site and pay particular attention to the character, height/depth below ground level, condition, date and significance of any archaeological deposits.

4 METHODOLOGY

4.1 Introduction

4.1.1 All fieldwork was conducted in accordance with the methodology set out in the Specification (SWAT 2018) and carried out in compliance with the standards outlined in the Chartered Institute for Archaeologists' Standards Guidance for Archaeological Evaluations (CIfA 2014).

4.2 Fieldwork

4.2.1 A total of 29 evaluation trenches were proposed within the extents of the Site (SWAT 2018).

4.2.2 Each trench was initially scanned by metal detector for surface finds prior to excavation. Excavation was carried out using a 360° mechanical excavator fitted with a toothless ditching bucket, removing the overburden to the top of the first recognisable archaeological horizon, under the constant supervision of an experienced archaeologist.

4.2.3 Where appropriate, trenches, or specific areas of trenches, were subsequently hand-cleaned to reveal features in plan and carefully selected cross-sections through the features were excavated to enable sufficient information about form, development date and stratigraphic relationships to be recorded without prejudice to more extensive investigations, should these prove to be necessary. All archaeological work was carried out in accordance with KCC and CIfA standards and guidance. A complete photographic record was maintained on site that included working shots; during mechanical excavation, following archaeological investigations and during back filling.

4.2.4 On completion, the trenches were made safe and left open in order to provide the opportunity for a curatorial monitoring visit. Backfilling was carried out once all recording, survey and monitoring had been completed.

4.3 Recording

- 4.3.1 A complete drawn record of the evaluation trenches comprising both plans and sections, drawn to appropriate scales (1:20 for plans, 1:10 for sections) was undertaken. The plans and sections were annotated with coordinates and aOD heights.
- 4.3.2 Photographs were taken as appropriate providing a record of excavated features and deposits, along with images of the overall trench to illustrate their location and context. The record also includes images of the Site overall. The photographic record comprises digital photography. A photographic register of all photographs taken is contained within the project archive.
- 4.3.3 A single context recording system was used to record the deposits. A full list is presented in Appendix 1. Layers and fills are identified in this report thus (100), whilst the cut of the feature is shown as [100]. Context numbers were assigned to all deposits for recording purposes. Each number has been attributed to a specific trench with the primary number(s) relating to specific trenches (*i.e.* Trench 1, 101+, Trench 2, 201+, Trench 3, 301+ etc.).

5 RESULTS

5.1 Introduction

- 5.1.1 A total of 29 evaluation trenches were mechanically excavated under archaeological supervision. Trenches were positioned in order to cover as many areas of the site as possible, whilst taking into consideration geophysical anomalies identified in the earlier survey. Individual trench results are discussed below.
- 5.1.2 Figure 1 & Figure 2 provide a site plan and trench location plan. Figure 3 provides an archaeological plan overlaying the proposed development while Figures 4 and 5 show the results of the geophysical survey and trenches. Figures 5-16 illustrate the results for each individual archaeological evaluation trench. In addition to the plans provided, this report also contains representative sections for all excavated features (Figure 17 – Figure 19).
- 5.1.3 Plates 1-48 consist of photographs of features and selected trenches that have been provided to supplement the text.
- 5.1.4 Appendix 1 provides the stratigraphic sequence and contextual information for all trenches.

5.2 Stratigraphic Deposit Sequence

- 5.2.1 A relatively consistent stratigraphic sequence was recorded across the majority of the Site comprising topsoil sealing an intact subsoil, which overlay the natural chalk geology.

5.2.2 The topsoil generally consisted of mid grey brown friable silt, moderate roots and occasional small rounded stones, topped with grass, overlying the subsoil which consisted of mid brown silt subsoil. Natural geology comprised of West Melbury Marley Chalk Formation.

5.3 Archaeological Narrative

Negative trenches

5.3.1 Of the twenty-nine trenches originally planned Trenches 6, 8, 9, 12, 16, 17, 18-29 were all blank. The remaining 11 trenches had features of archaeological interest and are described in more detail below.

5.3.2 Trench 21, which was positioned to target a large geophysical anomaly and is detailed on Figure 16, contained a large modern pit that was investigated by machine. No further recording was carried out on this feature.

Trench 1 (Figure 5, Plates 2-5)

5.3.3 Within the south-western corner of the site, Trench 1 was excavated on an ESE-WNW alignment and measured 30m in length with a maximum depth of 0.75m (Figure 5). At the western extent of the trench a single, oval shaped pit [105] had steep sides and a flat base and was circular in plan with a diameter of approximately 1.35m and a depth of 0.30m (Figure 17). The single fill (106) comprised dark grey-brown clay silt which contained two fragments of Romano-British pottery and a single struck flint.

5.3.4 Within the eastern extent of the trench the second feature consisted of a N-S orientated ditch measuring 0.75m in width [107]. The single fill (108) comprised firm, compact re-deposited chalk. No finds were associated with ditch although it was considered modern in date.

Trench 2 (Figure 6, Plates 6-28)

5.3.5 Trench 2 was located adjacent to the southern extent of the site and initially excavated on a NNE-SSW alignment and measured 30m in length, 1.8m in width and between 0.50m and 0.90m in depth (Figure 6). The presence of archaeological deposits, in particular a compact floor surface and series of post holes, within this trench prompted a series of additional excavated extensions in order to identify the extent of the possible surface (Figure 6).

5.3.6 The dominant archaeological feature within this trench is the possible surface recorded as (204=223). Extending to approximately 12m in width, with a length of at least 30m, this layer consisted of firm compact dark brown clay silt with frequent flint, animal bones, pottery sherds, CBM and iron nails, to an average depth of approximately 0.1m. This layer overlay an earlier eroded

surface which consisted of compact cobbles (219, 220, 221 and 222) which, in the northern extent of the trench, were formed around a large posthole [216] measuring 0.6m in diameter with a depth of 0.65m.

5.3.7 Within the northern extent of the trench five additional post holes [205, 207, 210, 212 & 214] formed a clear alignment orientated on a NNE-SSW alignment (Figure 17). These postholes measured between 0.32m and 0.74m in width, were largely ovoid in plan and contained fills which included packing stones (206, 208, 211, 213 and 215). Initial thoughts suggest that the characteristics of these five post holes, along with post hole [216], which was also supported by packing/supporting sandstone blocks (218), are indicative of structural post associated with a building. This being the case, it is likely that the early surface (219, 220, 221 and 222) and the later surface (204 & 223) are associated with the building(s) and that the presence and number of finds scattered within layer (204) suggest some sort of working floor.

5.3.8 Although the nature and dating of these features is only provisional at this stage, it is possible to suggest that features within this trench form part of a small timber building dating to the late 2nd /early 3rd century. Further consideration is given to this structure in Section 7 below.

Trench 3 (Figure 7, Plate 29)

5.3.9 Located directly adjacent and to the east of Trench 2, within the southern extent of the site, Trench 2 contained the eastern most extent of the previously recorded 'trample' layer (304). The material was consistent with that recorded in Trench 2, consisting of firm dark brown cay silt with moderate flint inclusions. No dateable material was retrieved from the deposit within this trench.

Trench 4 (Figure 8, Plates 30-32)

5.3.10 Located directly north of Trench 2, within the central southern extent of the site, Trench 2 was positioned to target the southern extent of the potential enclosure identified during the geophysical survey. The trench was excavated on an ESE-WNW alignment and measured 30m in length with a maximum depth of 0.5m (Figure 8).

5.3.11 Two NW-SE aligned parallel linear features were exposed in this trench [404 & 408]; linear [408] was only partially visible beneath the western extent of the trench and therefore not investigated at this location. The ditch, which ties in with a geophysical anomaly, continued into Trench 5 to the west where investigation and recording was carried out (see below). Directly adjacent, the second ditch [404] measured 0.95m in width with a depth of 0.65m (Figure 17). The single fill comprised firm mid brown silty clay with occasional flints and patches of re-deposited natural clay and chalk (405). This fill contained CBM, animal bones, Romano-British pottery sherds.

- 5.3.12 Although the two above mentioned ditches were clearly parallel (from both the geophysical results and the physical proximity within the trench) it was clear that they were not contemporary. Directly to the east of intervention [404] the difference in fill was clearly distinctive. Ditch [408] changed alignment just south of the extent of Trench 4 and directly cut the earlier ditch [404] within the trench. Recorded as [406] (407) this feature was further investigated within Trench 7 to the north.

Trench 5 (Figure 9, Plates 33-35)

- 5.3.13 Located on the western extent of the site the trench measured 29.1m in length with a maximum depth of 0.5m. The trench was oriented NNE-SSW and revealed the continued presence of two linear features identified within Trench 4 to the east, and the previously carried out geophysical survey.
- 5.3.14 The first linear feature [504] was the southern-most of the two linear features and was aligned NW-SE (Plate 5) aligning with ditch [408] in Trench 4. Investigation of the ditch revealed a wide V-shaped profile, with a width of 0.85m, a depth of 0.35m and a single fill (505) that comprised compact dark brown silty clay with frequent flints and occasional chalk and charcoal (Figure 18). Two small sherds of Roman pottery were recovered from this fill.
- 5.3.15 To the immediate north, the parallel ditch [507] contained a fill which consisted of firm mid orange brown silty clay with frequent flints (508). This feature was not investigated within this trench.

Trench 7 (Figure 11, Plates 38-40)

- 5.3.16 Within the central-western extent of the site, Trench 7 was excavated on a NNE-SSW alignment and measured 28.64m in length with a maximum depth of 0.50m. Running almost the entire length of the trench, linear [704] was visible for a length of at least 25m? and continued north into Trench 10 and connected with ditch [406] in Trench 4 to the south. The ditch [704] had steep sides and a stepped base and measured 1.45m in width and a depth of 0.30m. The fill (705) comprised firm dark brown silty clay with moderate flints, occasional chalk, animal bone and two fragments of Roman pottery.

Trench 10 (Figure 12, Plate 43)

- 5.3.17 Within the central-western extent of the site, adjacent and to the north of Trench 7, Trench 10 was excavated on an ESE-WNE alignment, measured 30.6m in length, 0.45m in depth and contained two linear features and a single oval pit. This trench was also positioned to target the possibly enclosure highlighted by the geophysical survey.
- 5.3.18 Linear feature [1004] was situated at the eastern end of the trench. Aligned NE-SW, the ditch had a width of 2.08m (Figure 12, Section 33) and contained an upper fill (1005) of mid brown clay silt.

This feature was not investigated further but clearly formed the eastern enclosure ditch recorded within Trench 10 and Trench 7 to the south and the results of the geophysical survey.

- 5.3.19 Within the western extent of the trench feature [1008] was initially thought to represent a ditch but later proved to be an undulation filled with subsoil. Adjacent and to the east pit [1006] was only partially visible, disappearing beneath the southern baulk of the trench. This investigated feature was filled by firm dark brown grey clay silt with occasional flint.

Trench 11 (Figure 13, Plates 44-47)

- 5.3.20 Within the western extent of the site, adjacent and to the west of Trench 10, Trench 11 was excavated on an NNE-SSW alignment, measured 29.3m in length, 0.37m in depth and contained a linear feature and a single pit. This trench was positioned to target the possible enclosure highlighted by the geophysical survey.

- 5.3.21 Within the northern extent of the trench ditch [1104] measured 3.45m in width with a maximum depth of 1.00m (Figure 18). The ditch contained three fills (1105, 1106 & 1107) producing Romano-British tile (1107), pottery (1105) and animal bone (1107). The location of the ditch corresponding with the results of the geophysical survey confirming the presence of the northern extent of the enclosure ditch recorded in Trenches 4, 5, 7, 10 and 13.

- 5.3.22 A small pit measuring 0.8m in diameter and 0.3m in depth [1108] was located within the southern extent of the trench and contained a single fill comprising firm dark brownish grey, clayey silt with moderate flint and chalk flecks (1109). A thin charcoal layer at the bottom overlay the natural burnt chalk (Figure 18).

Trench 13 (Figure 14, Plate 48)

- 5.3.23 Located within the northern extent of the Site Trench 13 measured 30.7m in length with a maximum depth of 0.72m. Within the far southern extent of this trench the single linear revealed consisted of the northern edge of the enclosure ditch identified on the geophysical survey (1304). No investigation work was carried out on this feature.

Trench 14 (Figure 15, Plate 48)

- 5.3.24 Within the northern extent of the site, Trench 14 was excavated on an NW-SE alignment, measured 28.5m in length, 0.50m in depth and was positioned to examine a linear feature identified during the geophysical survey (Figure 4 and Figure 15). The presence of the feature was confirmed with the presence of a single linear ditch located within the southern extent of the trench.

5.3.25 Ditch [1404] was aligned NE-SW with moderately sloped sides and a concave base (Figure 19). The feature measured approximately 1.15m in width and 0.3m in depth and contained a single fill which consisted of firm dark grey brown silty clay with frequent flint inclusions (1405). This fill contained 11 sherds of Roman pottery.

Trench 15

5.3.26 Located within the northern extent of the Site, Trench 15 measured 28.86m in length with a maximum depth of 0.55m. Within the far northern extent of this trench the single linear revealed, consisted of the eastern edge of the field boundary identified on the geophysical survey and within Trench 14 (detailed above). No investigation work was carried out on this feature.

6 FINDS

6.1 Quantification of Archaeological Material

6.1.1 Finds comprised of 100 sherds of pottery (from small enclosure ditches and large field boundary), worked flint, animal bone, roof tile and iron nails. Table 2 provides a quantification of the archaeological material collected, along with spot dates provided for the phasing of archaeological features.

Deposit	Cut	Material	Description	Quantity	Dating
106	105	Pottery	Two small sherds of Roman pottery	1 bag	c.AD170-270
106	105	Flint	Flint flake	1 bag	
204		Sandstone	Fragment of flat stone	1 bag	
204		CBM	Roman roof tile small fragments Tile fragments	2 bags 1 bag	
204		Iron	Nail – Roman 8 Roman nails and blade	1 bag 1 bag	
204		Bone	1 bone Few fragments and some teeth Big bag full of small and medium fragments	1 bag 1 bag 1 bag	
204		Pottery	3 small sherds of Roman pottery 21 small/medium fragments	21 sherds	c.AD270-370
204		Flint	Blade and flecks - residual	1 bag	
206	205	Bone	Rib fragment	1 bag	
206	205	Pottery	16 medium and small fragments of Roman pottery	16 sherds	c. AD270-370
208	207	Bone	Small fragment 4 small fragments	1 bag 1 bag	
208	207	Pottery	Small sherd	1 bag	c. AD180-370
211	210	Iron	Roman nail	1 bag	
213	212	Iron	Small hook – Roman	1 bag	

Deposit	Cut	Material	Description	Quantity	Dating
			Roman nail	1 bag	
213	212	Bone	Complete bone –sheep? Few medium/ small fragments	1 bag 1 bag	
213	212	Flint	Blade fragment - residual	1 bag	
213	212	Pottery	11 sherds of Roman pottery	11 sherds	c. AD220-30
213	212	CBM	2 medium fragments	2 fragments	
215	214	Bone	Few small/medium fragments	1 bag	
215	214	Pottery	14 small/medium fragments of Roman pottery	14 sherds	c.AD160-350
217	216	Pottery	Two sherds of Roman pottery	2 sherds	c. AD150-270
217	216	Bone	1 small fragment	1 fragment	
217	216	CBM	2 fragments	2 fragments	
217	216	Iron	Roman nail	1 bag	
220		pottery	Roman rim fragment	1 bag	c.AD220-300
220		CBM	Small fragments of Roman tile and Medieval?	1 bag	
221		Pottery	10 small fragments of roman pottery	10 sherds	c.AD150-270
221		Iron	Nail - Roman	1 bag	
221		CBM	2 small fragments of roof tile	2 fragments	
222		Bone	One big fragment of animal bone 3 rib fragments small and medium	1 bag 1 bag	
222		Pottery	Quarter of the base fragment - Roman	1 bag	c.AD200-400
222		Iron	Nail fragment	1 bag	
222		CBM	2 fragments of tile	2 fragments	
223		CBM	Roman roof tile fragments	2 bags	
405		Bones	Animal large leg bones (cow) and small fragments	1 bag	
405		Pottery	2 medium sherds of Roman pottery and few tiny ones	2 sherds	c.AD150-200
505	504	Pottery	Two small sherds	1 bag	
505	504	Iron	Roman nail	1 bag	
505	504	Bones	Few mid and small bone fragments	1 bag	
705	704	Bones	Large bag filled with animal bone all size fragments	1 bag	
705	704	Pottery	Two rim fragments of Roman pottery	1 bag	c. AD270-420 c.AD300-350
1105	1104	Pottery	Small Roman sherd	1 bag	c.AD200-300
1107	1104	Bones	Animal large bones (cow) and small fragments	1 bag	
1107	1104	CBM	Few fragments of Roman tile	1 bag	
1405	1404	CBM	Roman roof tile fragments	1 bag	
1405	1404	Bones	Big and small fragments of animal bone	1 bag	
1405	1404	Pottery	11 small and medium sherds of Roman pottery	11 sherds	c.AD270-420

Table 2 Quantification of the Archaeological Material

- 6.1.2 In order to facilitate the urgency of the submission of this report, archaeological features have been spot dated by a specialist so that chorological phasing of archaeological features can be included. All dateable finds retrieved during the course of the fieldwork have been associated with the Roman period (excluding obvious modern material).
- 6.1.3 The lack of military finds and frequency of more domestic wares would support the idea that the site is more agricultural in character. No high-status finds are among the assemblage.
- 6.1.4 In the event that there is further fieldwork, it is recommended that the archive created from this evaluation be added to future archives so that a more complete assessment can be made.

7 DISCUSSION

7.1 Introduction

- 7.1.1 The archaeological evaluation at Tanyard Farm, Lenham, Kent, has demonstrated the presence of archaeological activity within the extents of the proposed development area. The natural geology was encountered at an average depth of approximately 0.5m below the existing ground surface, directly underlying a subsoil sealed by the existing topsoil, within an undulating rural landscape. Rapid cartographic regression suggests that the site has been relatively undisturbed throughout the past 150 years, confirmed during the evaluation, as any modern truncation was limited to low impact land drains and rooting.
- 7.1.2 The geophysical survey, carried out by SUMO Services Limited, suggested that the presence of archaeological features would be limited, although it was considered a possibility that features associated with the Roman period may be present. The archaeological evaluation therefore targeted potential features, as well as blank areas, and was successful in confirming the presence of Romano-British ditches associated with a small enclosure and earlier, larger field system. The use of geophysical survey techniques is therefore considered a reliable indicator of the presence of '*probable or possible*' (SUMO 2018: 4.1) archaeological features.

7.2 Archaeological Narrative

- 7.2.1 The archaeological evaluation has been successful in identifying the presence of ditches, postholes and compact floor surfaces associated with the Roman-British period. Archaeological features were recorded in Trenches 1, 2, 3, 4, 5, 7, 10, 11, 13, 14 and 15.
- 7.2.2 Trenches 4, 5, 7, 10 and 11 identified the presence of a small ditched enclosure, which is likely to continue to the west, and with a convincing a V-shaped profile common with features of a Roman-British date. Finds from the ditch have suggested that the enclosure dates from the late 3rd-4th

century. No evidence for any associated structures were found within this enclosure. The corners of the enclosure seem not to be rounded, as may be expected if the earthwork was associated with military works (Dr Paul Wilkinson *per comm*), but more likely to be agricultural/pastoral such as a smallholding or a farm with the used for the management and use of livestock.

7.2.3 Pre-dating the enclosure, a single ditch is initially orientated NW-SE before turning through 90° and heading towards the northeast. This ditch is cut by the small enclosure, although both do share the same location and orientation along the southern extent of the site. The stratigraphic relationship between the two features is confirmed by the dating of finds which suggest that the larger field system dates to the late 2nd century.

7.2.4 Directly adjacent to the southern corner of the larger field system and within Trench 2 and Trench 3 are the remains of a post-built timber framed Roman building with six large postholes has also been dated by Roman pottery found within the post holes and on the cobbled surfaces associated with the building.

7.2.5 To summarise, the archaeological evaluation has recorded the presence of a small enclosure dating to the late 3rd-4th century which has replaced a larger open field system that dates to the latter part of the 2nd century. An area within the southern extent of the site contains at least two floors, one on top of the other, that are formed around a series of structural post holes, in alignment, that were probably associated with a structure of some kind. The dating for the structure seems to favour late 2nd-3rd century so it is plausible to suggest a contemporary relationship with the open field system to the immediate north.

7.2.6 There is nothing to suggest a high status or military settlement and that evidence to date suggests a small Romano-British farmstead within the western extent of the proposed development site. Given the known layout and methodology of Roman farms (villas) in Britain it is likely the main buildings will be clustered downslope and off site around the freshwater springs with the main house situated in the south west area of the complex facing south east whilst the farm buildings (one onsite) will be situated to the north east with the prevailing south west winds ensuring farmyard 'smells' do not permeate the residential areas of the farm.

7.3 Recommendations

7.3.1 In the event that finished ground levels remain constant, the depth of impact associated with future development is likely to require the excavation of material exceeding 0.50m in depth. In the absence of ground raising, proposed impacts to archaeological horizons throughout the site are expected.

7.3.2 Development proposals are likely to impact on archaeological remains. It is therefore recommended that further archaeological mitigation is focussed on targeted areas of excavation which can be carried out as part of a planning condition. The nature and scope of any further archaeological mitigation will need to be determined in consultation with the Senior Archaeological Advisor at Kent County Council.

7.4 Conclusions

7.4.1 The archaeological evaluation has been successful in fulfilling the primary aims and objectives of the Specification.

7.4.2 This evaluation has, therefore, assessed the archaeological potential of land intended for development. The results from this work will be used to aid and inform the Senior Archaeological Officer and Planning Officer of any further archaeological mitigation measures that may be necessary in connection with any future development proposals.

8 ARCHIVE

8.1 General

8.1.1 The Site archive, which will include; paper records, photographic records, graphics and digital data, will be prepared following nationally recommended guidelines (SMA 1995; ClfA 2009; Brown 2011; ADS 2013).

8.1.2 All archive elements will be marked with the site/accession code, and a full index will be prepared. The physical archive comprises 1 file/document case of paper records & A4 graphics. The Site Archive will be retained at SWAT Archaeology offices until such time it can be transferred to a Kent Museum.

9 ACKNOWLEDGMENTS

9.1.1 SWAT would like to thank ROGATE for commissioning the project. Thanks are also extended to Wendy Rogers, Senior Archaeological Officer at Kent County Council, for her advice and assistance.

9.1.2 Peter Cichy supervised the archaeological fieldwork; illustrations were produced by Bartek Cichy. David Britchfield BA MCIfA produced the draft text for this report. The Project Manager for the project was Dr Paul Wilkinson MCIfA, FRSA.

10 REFERENCES

ADS 2013. Caring for Digital Data in Archaeology: a guide to good practice, Archaeology Data Service & Digital Antiquity Guides to Good Practice

Brown, D.H., 2011. Archaeological archives; a guide to best practice in creation, compilation, transfer and curation, Archaeological Archives Forum (revised edition)

Canterbury Archaeological Trust, 2015, Ashford Road, Lenham, Kent; Desk-Based Assessment. CAT Report No. 2015/67

Chartered Institute for Archaeologists, 2009, Standard and Guidance for the creation, compilation, transfer and deposition of archaeological archives, Institute for Archaeologists

Chartered Institute for Archaeologists, 2014, *Standard and guidance: for field evaluation.*

Chartered Institute for Archaeologists, 2014, *Standard and guidance for the creation, compilation, transfer and deposition of archaeological archives.*

Department of the Environment, 2010, *Planning for the Historic Environment*, Planning (PPS 5) HMSO.

English Heritage 2002. Environmental Archaeology; a guide to theory and practice of methods, from sampling and recovery to post-excavation, Swindon, Centre for Archaeology Guidelines

English Heritage, 2006, *Management of Research Projects in the Historic Environment (MoRPHE).*

SMA 1993. Selection, Retention and Dispersal of Archaeological Collections, Society of Museum Archaeologists

SMA 1995. Towards an Accessible Archaeological Archive, Society of Museum Archaeologists

Sumo Survey, 2018, Groom Way, Lenham, Kent. Survey Report No. 13101

SWAT Archaeology, 2018, Specification for a Programme of Archaeological Evaluation at Tanyard Farm, Lenham, Kent

11 APPENDIX 1 – TRENCH TABLES

Trench 1	Dimensions: 30m x 1.8m Depth: 0.75m Trench alignment: ESE-WNW WNW-end Ground Level: 109.92m OD; ESE-end Ground Level: 110.07m OD		
Context	Description	Interpretation	Depth (m)
101	Firm compaction, Dark brownish grey, clayey silt, occ. Flints.	Topsoil Ploughed soil	0.00-0.3
102	Firm compaction, medium brown, clayey silt with moderate flints.	Subsoil Colluvium	0.3-0.7
103	Mid orange brown, silty clay with moderate sub angular flints.	Natural Periglacial	0.6+
104	White, weathered chalk bedrock with moderate flint nodules.	Natural Bedrock	0.6+
[105]	Circular in plan, steep sides, flat base. Feature measured 1.35m in diameter and was 0.3m deep.	Cut of Roman pit	0.7-1
106	Firm compaction, dark brownish grey, clayey silt with moderate flint, chalk and occ. Pottery.	Secondary fill of [105]	0.7-1
[107]	N-S aligned linear, unexcavated. Feature was 0.75m wide.	Cut of modern trench	0.3+
108	Firm compaction, re deposited chalk.	Backfill of [107]	0.3+

Trench 2	Dimensions: 27m x 1.8m Depth: 0.5m at NNE end, 0.9m at SSW end Trench alignment: NNE-SSW NNE-end Ground Level: 110.37m OD SSW-end Ground Level: 110m OD Three extensions of the trench were excavated. Two perpendiculars and one at a 45-degree angle. Perpendicular extension A was 10m long, excavated at S end of the trench in west-north-west direction. Perpendicular extension B was 17m long, excavated 8 metres from S end of the trench in east-south-east direction Angled extension C was 12m long, excavated from the middle of the trench in east direction. The purpose of extensions was to estimate extents of Roman deposits.		
Context	Description	Interpretation	Depth (m)
201	Firm compaction, Dark brownish grey (blackish), clayey silt, occ. Flints.	Topsoil Ploughed soil	0.00 - 0.3
202	Firm compaction, dark brown, clayey silt with moderate flints.	Subsoil Colluvium	0.3 - 0.9
203	Mid orange brown, silty clay with moderate sub angular flints.	Natural Periglacial	0.6+
204	Firm compaction, dark brown clayey silt with freq. flints, animal bones, pottery sherds, CBM, iron nails, occ. sandstone, chalk and charcoal flecks. All inclusions were randomly placed within a context. Average thickness: 0.1m. Context was overlaying stone deposits 209, 219, 220, 221, 222, 223.	Roman trample layer	0.6 +
[205]	Oval in plan, moderate sides, tapered to a point base. Feature measured 0.68m by 0.5m and was 0.2m deep.	Cut of Roman post hole	0.5 - 0.7
206	Mid compaction, dark brown, clayey silt with freq. flint, and occ. pottery, CBM, animal bone.	Secondary fill of [205]	0.5 – 0.7

[207]	Oval in plan, moderate sides, tapered to a point base. Feature measured 0.58m by 0.74m and was 0.2m deep.	Cut of Roman post hole	0.5 – 0.7
208	Mid compaction, dark brownish grey, clayey silt with freq. flint, and occ. pottery, CBM, animal bone.	Secondary fill of [207]	0.5 – 0.7
209	Small linear concentration of flint cobbles and big rectangular sandstone. Context measured 0.85m by 0.5m and was overlaid by (204).	Stone deposit	0.52 -0.7
[210]	Oval in plan, moderate sides, flat base. Feature measured 0.7m by 0.47m and was 0.2m deep.	Cut of Roman post hole	0.53 – 0.73
211	Mid compaction, dark brownish grey, clayey silt with freq. flint, and occ. pottery, CBM, animal bone.	Secondary fill of [207]	0.53 – 0.73
[212]	Oval in plan, steep sides, concave base. Feature measured 0.41m by 0.32m and was 0.2m deep. Only post pipe has been excavated. Post pack consisting flint nodules has been left in situ.	Cut of Roman post hole – post pipe	0.62 – 0.8
213	Mid compaction, dark brownish grey, clayey silt with freq. flint, and occ. pottery, CBM, animal bone.	Secondary fill of [207] – post pipe	0.62 – 0.8
[214]	Oval in plan, steep sides, flat base. Feature measured 0.41m by 0.5m and was 0.2m deep.	Cut of Roman post hole	0.7 – 0.9
215	Mid compaction, dark brownish grey, clayey silt with freq. flint, and occ. pottery, CBM, animal bone.	Secondary fill of [207]	0.7 – 0.9
[216]	Circular in plan, steep sides, concave base. Feature measured 0.6m in diameter and was 0.65m deep.	Cut of Roman post hole – post pipe	0.65 – 1.3
217	Mid compaction, dark brownish grey, clayey silt with occ. flint, pottery, CBM, animal bone.	Secondary fill of [216]	0.65 – 1.3
218	Unexcavated post pack consisting flints and two (0.5mx0.5m) sandstone boulders carved to support a post, placed next to each. The edge of boulders is forming sort of half circle in plan.	Post pack of [216]	0.65 – 1.3
219	Compacted flint cobble surface located around post hole [216] and overlaid by 204. Northern E-W aligned edge of the context was exposed. Context measured 1.7m by 3m.	Roman floor	0.7 – 0.8
220	Shape in plan was narrow L with wide rounded ends. Concentration of small flint cobbles. Context measured 3.8 by 0.3m. Possibly an outcrop in (204) of the floor (219).	Roman stone deposit – Probably floor as (219)	0.8+
221	Irregular in plan, small bank made of compacted flint cobbles seemed to be robbed out. Context measured 3.1 by 1m and continues into western wall of the trench Might be remains of green wall.	Roman stone deposit – Probably short green wall	0.75+
222	Narrow curvilinear in plan, N-S aligned, Loose flint gravel. Context measured 4.3m by 0.4m.	Roman stone deposit	0.9+
223	Firm compaction, dark brown clayey silt with moderate flints, animal bones, pottery sherds, CBM, iron nails, occ. sandstone, chalk and	Roman trample Layer	0.9+

	charcoal flecks. All inclusions were randomly placed within a context. Context located on SW side of (222) at S end of the trench. Same as (204).		
224	Rectangular in plan, fairly loose flint gravel. Context measured 2m by 0.8m and continues into eastern wall of the trench. Deposit located between post holes [210] and [214] was overlaid by (204).	Roman stone deposit - floor	0.5 - 0.6
225	Very light grey/ white, weathered chalk bedrock with moderate flints and chalk silt pockets.	Natural – Chalk bedrock	0.5+

Trench 3	Dimensions: 30m x 1.8m Depth: 0.85m Trench alignment: ESE-WNW WNW-end Ground Level: 110.21m OD; ESE-end Ground Level: 110.01m OD		
Context	Description	Interpretation	Depth (m)
301	Firm compaction, Dark brownish grey, clayey silt, moderate flints.	Topsoil Ploughed soil	0.00-0.3
302	Firm compaction, medium brown, clayey silt with moderate flints.	Subsoil Colluvium	0.3-0.8
303	Mid orange brown, silty clay with moderate sub angular flints.	Natural Periglacial	0.6+
304	Firm compaction, dark brown clayey silt with freq. flints, occ. animal bone and CBM.	Roman trample layer	0.8+

Trench 4	Dimensions: 30m x 1.8m Depth: 0.5m Trench alignment: ESE-WNW WNW-end Ground Level: 110.68m OD; ESE-end Ground Level: 110.47m OD		
Context	Description	Interpretation	Depth (m)
401	Firm compaction, Dark brownish grey, clayey silt, occ. flints.	Topsoil Ploughed soil	0.00-0.3
402	Firm compaction, medium brown, clayey silt with moderate flints.	Subsoil Colluvium	0.3-0.4
403	White, chalk bedrock with moderate flint nodules.	Natural Bedrock	0.3+
[404]	Linear in plan, NW-SE aligned ditch with steep sides and narrow concave base. Feature was 0.95m wide and 0.65m deep. Feature was truncated by perpendicularly aligned Roman ditch [406].	Cut of Roman ditch	0.4 - 1.05
405	Firm compaction, medium brown silty clay with occ. flints and patches of re deposited natural clay, chalk. Recovered finds: CBM, animal bones, pottery sherds.	Fill of Roman ditch [404] - backfill	0.4 - 1.05
[406]	Linear NE-SW aligned ditch was 1m wide and cuts through ditch [404]. Unexcavated context. Feature was excavated in Trench 7.	Cut of Roman ditch	0.4+
407	Firm compaction, dark brown clayey silt with occ. flint and charcoal flecks. Un excavated context.	Secondary fill of [406]	0.4+
[408]	Linear NE-SW aligned ditch. Un excavated context, only fragment exposed in trench corner. Feature was excavated in Trench 5.	Cut of Roman ditch	0.3+

409	Firm compaction, dark brown clayey silt with occ. flint and charcoal flecks. Un excavated context.	Secondary fill of [408]	0.3+
-----	--	-------------------------	------

Trench 5	Dimensions: 29.1m x 1.8m Depth: 0.5m Trench alignment: NNE-SSW NNE-end Ground Level: 110.96m OD; SSW-end Ground Level: 110.10m OD		
Context	Description	Interpretation	Depth (m)
501	Firm compaction, Dark brownish grey, clayey silt, occ. Flints.	Topsoil Ploughed soil	0.00-0.3
502	Firm compaction, medium brown, clayey silt with moderate flints.	Subsoil Colluvium	0.3-0.45
503	White, chalk bedrock with moderate flint nodules. Undulating chalk surface.	Natural Bedrock	0.3+
[504]	Linear in plan, NW-SE aligned ditch with V-shaped profile. Feature was 0.85m wide and 0.35m deep.	Cut of Roman ditch	0.35 – 0.7
505	Firm compaction, dark brown silty clay with freq. flints, occ. chalk and charcoal flecks.	Fill of Roman ditch [504] -	0.35 – 0.7
506	Mid orange brown, silty clay with moderate sub angular flints.	Natural Periglacial	0.3+
[507]	Linear in plan, NW-SE aligned ditch with steep sides. Partially excavated. Backfilled with natural clay. Feature has been exposed and excavated in Trench 4.	Cut of Roman ditch	0.3+
508	Firm compaction, mid. orangish brown silty clay with freq. flints. Lack of visible anthropogenic inclusions, partially excavated. Backfilled with natural clay. Feature has been exposed and excavated in Trench 4.	Fill of Roman ditch [504] - backfill	0.3+

Trench 6	Dimensions: 31.7m x 1.8m Depth: 0.45m Trench alignment: ESE-WNW ESE-end Ground Level: 111.22m OD; WNW-end Ground Level: 111.15m OD		
Context	Description	Interpretation	Depth (m)
601	Firm compaction, Dark brownish grey, clayey silt, occ. Flints.	Topsoil Ploughed soil	0.00-0.3
602	Firm compaction, medium brown, clayey silt with moderate flints.	Subsoil Colluvium	0.3-0.45
603	White, soft chalk bedrock with moderate flint nodules. Undulating chalk surface with scars and patches of (604).	Natural Bedrock	0.3+
604	Mid orange brown, silty clay with moderate sub angular flints.	Natural Periglacial	0.3+
605	Modern service trench also exposed in trench 1	Modern trench	0.3+
606	NNE-SSW Linear, 2m wide turned to be a top soil left over natural.	Top soil left over	0.3-0.34

Trench 7	Dimensions: 28.64m x 1.8m Depth: 0.5m Trench alignment: NNE-SSW NNE-end Ground Level: 110.96m OD; SSW-end Ground Level: 110.10m OD		
Context	Description	Interpretation	Depth (m)
701	Firm compaction, Dark brownish grey, clayey silt, occ. Flints.	Topsoil Ploughed soil	0.00-0.3

702	Firm compaction, medium brown, clayey silt with moderate flints.	Subsoil Colluvium	0.3-0.4
703	White, soft chalk bedrock with moderate flint nodules. Undulating chalk surface.	Natural Bedrock	0.3+
[704]	Linear in plan, NE-SW aligned ditch with west side steep, east side steep and stepped and flat base. Feature was 1.45m wide and 0.3m deep. Feature was exposed also in Trench 4 and 10.	Cut of Roman ditch	0.35 – 0.7
705	Firm compaction, dark brown silty clay with moderate flints and chalk flecks, occ. pottery sherds, tile and animal bone. Finds located in upper section of the context.	Fill of Roman ditch [504] -	0.35 – 0.7
706	Mid orange brown, silty clay with moderate sub angular flints.	Natural Periglacial	0.35+

Trench 8	Dimensions: 29.1m x 1.8m Depth: 0.5m Trench alignment: NNE-SSW NNE-end Ground Level: 111.11m OD; SSW-end Ground Level: 110.24m OD		
Context	Description	Interpretation	Depth (m)
801	Firm compaction, Dark brownish grey, clayey silt, occ. Flints.	Topsoil Ploughed soil	0.00-0.3
802	Firm compaction, medium brown, clayey silt with moderate flints.	Subsoil Colluvium	0.3-0.5
803	Mid orange brown, silty clay with moderate sub angular flints.	Natural	0.5+

Trench 9	Dimensions: 30.7m x 1.8m Depth: 0.48m Trench alignment: NNE-SSW NNE-end Ground Level: 112.35m OD; SSW-end Ground Level: 111.36m OD		
Context	Description	Interpretation	Depth (m)
901	Firm compaction, Dark brownish grey, clayey silt, occ. Flints.	Topsoil Ploughed soil	0.00-0.3
902	Firm compaction, medium brown, clayey silt with moderate flints.	Subsoil Colluvium	0.3-0.4
903	Mid orange brown, silty clay with moderate sub angular flint.	Natural Periglacial	0.3+
904	White, soft chalk bedrock with moderate flint nodules. Undulating chalk surface.	Bedrock	0.3+

Trench 10	Dimensions: 30.6m x 1.8m Depth: 0.45m Trench alignment: ESE-WNW ESE-end Ground Level: 111.84m OD; WNW-end Ground Level: 111.75m OD		
Context	Description	Interpretation	Depth (m)
1001	Firm compaction, Dark brownish grey, clayey silt, occ. flints.	Topsoil Ploughed soil	0.00-0.3
1002	Mid orange brown, silty clay with moderate sub angular flints.	Natural Periglacial	0.3-0.45
1003	White, soft chalk bedrock with moderate flint nodules. Undulating chalk surface with scars and patches of (604).	Natural Bedrock	0.3+
[1004]	NE-SW aligned linear ditch. Feature was excavated in Trench 7.	Cut of Roman ditch	0.3+
1005	Firm compaction, medium brown, clayey silt with freq. flints. Feature was excavated in Trench 7.	Fill of [1004]	0.3+

[1006]	Corner of large oval pit – unexcavated. Probably modern, backfilled with (1007).	Pit	0.3+
1007	Firm compaction, mid brown clayey silt with freq. flints.	Fill of [1006] - backfill	0.3+
1007a	Re deposited chalk	Fill of [1006] - backfill	0.3+
[1008]	NNE-SSW Linear, 1.3m wide turned to be a top soil left over natural.	Top soil left over	0.3 - 0.33
(1009)	Firm compaction, Dark brownish grey, clayey silt, occ. flints.	Top soil left over – Fill of [1008]	0.3 – 0.33

Trench 11	Dimensions: 29.3m x 1.8m Depth: 0.37m Trench alignment: NNE-SSW NNE-end Ground Level: 112.24m OD; SSW-end Ground Level: 111.62m OD		
Context	Description	Interpretation	Depth (m)
1101	Firm compaction, Dark brownish grey, clayey silt, occ. flints.	Topsoil Ploughed soil	0.00-0.3
1102	Firm compaction, medium brown, clayey silt with moderate flints	Subsoil Colluvium	0.3-0.4
1103	White, soft chalk bedrock with moderate flint nodules. Undulating chalk surface with patches of mid brown clayey silt.	Natural Bedrock	0.4+
[1104]	Linear in plan, WNW-ESE aligned ditch with steep sides and narrow concave base. Feature was 3.45m wide and 1 m deep. Feature was exposed also in Trench 13.	Cut of Roman ditch	0.3 – 1.3
1105	Mid compaction, mid greyish brown, clayey silt with occ. flint. Context sampled 3 bags – Sample <1>	Primary fill of Roman ditch [1104] -	1.2 – 1.3
1106	Mid compaction, mid brown clayey silt with freq. flint, occ. pottery animal bones and CBM. Finds located in upper part of the context.	Secondary fill of Roman ditch [1104]	1.1 – 1.2
1107	Firm compaction, mid brown clayey silt with occ. flint and chalk flecks.	Secondary fill of Roman ditch [1104]	0.3 - 1.1
[1108]	Oval in plan, steep sides and flat base. Context measured 0.8m by 0.3m.	Cut of small fire pit	0.4 - 0.5
1109	Firm dark brownish grey, clayey silt with moderate flint and chalk flecks. Thin charcoal layer at the bottom overlaying natural burnt in situ.	Fill of [1108]	0.4 - 0.5

Trench 12	Dimensions: 29.8m x 1.8m Depth: 0.47m Trench alignment: ESE-WNW ESE-end Ground Level: 112.48m OD; WNW-end Ground Level: 112.52m OD		
Context	Description	Interpretation	Depth (m)
1201	Firm compaction, Dark brownish grey, clayey silt, occ. flints.	Topsoil Ploughed soil	0.00-0.3
1202	Firm compaction, medium brown, clayey silt with moderate flints.	Subsoil Colluvium	0.3-0.47
1203	White, soft chalk bedrock with moderate flint nodules. Undulating chalk surface with scars and patches of (604).	Natural Bedrock	0.4+

1204	Mid orange brown, silty clay with moderate sub angular flints.	Natural Periglacial	0.4+
[1205]	Linear NE-SW aligned with irregular sides and base. Filled with (1204).	Natural cut	0.4 – 0.6

Trench 13	Dimensions: 30.7m x 1.8m Depth: 0.72m Trench alignment: NNE-SSW NNE-end Ground Level: 113m OD; SSW-end Ground Level: 112.13m OD		
Context	Description	Interpretation	Depth (m)
1301	Firm compaction, Dark brownish grey, clayey silt, occ. Flints.	Topsoil Ploughed soil	0.00-0.3
1302	Firm compaction, medium brown, clayey silt with moderate flints.	Subsoil Colluvium	0.3-0.72
1303	White, soft chalk bedrock with moderate flint nodules. Undulating chalk surface.	Bedrock	0.7+
	Edge of ditch exposed at S end of the trench. Feature excavated in Trench 17.		

Trench 14	Dimensions: 28.5m x 1.8m Depth: 0.5m Trench alignment: NW-SE NW-end Ground Level: 112.76m OD; SE-end Ground Level: 112.32m OD		
Context	Description	Interpretation	Depth (m)
1401	Firm compaction, Dark brownish grey, clayey silt, occ. flints.	Topsoil Ploughed soil	0.00-0.3
1402	Firm compaction, medium brown, clayey silt with moderate flints.	Subsoil Colluvium	0.3-0.4
1403	White, soft chalk bedrock with moderate flint nodules. Undulating chalk surface.	Bedrock	0.3+
[1404]	Linear, NE-SW aligned ditch with moderate sides and concave base. Feature was 1.15m wide and 0.3m deep.	Cut of Roman ditch	0.3 – 0.6
1405	Firm compaction, dark greyish brown silty clay with freq. flints.	Fill of [1404]	0.3 – 0.6

Trench 15	Dimensions: 28.86m x 1.8m Depth: 0.55m Trench alignment: NNE-SSW NNE-end Ground Level: 112.76m OD; SSW-end Ground Level: 113.64m OD		
Context	Description	Interpretation	Depth (m)
1501	Firm compaction, Dark brownish grey, clayey silt, occ. flints.	Topsoil Ploughed soil	0.00-0.3
1502	Firm compaction, medium brown, clayey silt with moderate flints.	Subsoil Colluvium	0.3-0.55
1503	Mid orange brown, silty clay with moderate sub angular flints.	Natural Periglacial	0.55+

Trench 16	Dimensions: 28.3m x 1.8m Depth: 0.45m Trench alignment: NW-SE NW-end Ground Level: 114.13m OD; SE-end Ground Level: 113.24m OD Gap in trench for public footpath		
Context	Description	Interpretation	Depth (m)
1601	Firm compaction, Dark brownish grey, clayey silt, occ. flints.	Topsoil Ploughed soil	0.00-0.3
1602	Firm compaction, medium brown, clayey silt with moderate flints.	Subsoil Colluvium	0.3-0.4
1603	Mid orange brown, silty clay with moderate sub angular flints.	Natural Periglacial	0.4+

Trench 17	Dimensions: 28.3m x 1.8m Depth: 0.45m Trench alignment: W-S W-end Ground Level: 114.63m OD; S-end Ground Level: 113.66m OD		
Context	Description	Interpretation	Depth (m)
1701	Firm compaction, Dark brownish grey, clayey silt, occ. flints.	Topsoil Ploughed soil	0.00-0.3
1702	Firm compaction, medium brown, clayey silt with moderate flints.	Subsoil Colluvium	0.3-0.48
1703	Mid orange brown, silty clay with moderate sub angular flints.	Natural Periglacial	0.3+
1704	White, soft chalk bedrock with moderate flint nodules. Undulating chalk surface.	Bedrock	0.3+

Trench 18	Dimensions: 20.87m x 1.8m Depth: 0.42m Trench alignment: NNW-SSE NNW-end Ground Level: 112.55m OD; SSE-end Ground Level: 112.02m OD		
Context	Description	Interpretation	Depth (m)
1801	Firm compaction, Dark brownish grey, clayey silt, occ. flints.	Topsoil Ploughed soil	0.00-0.3
1802	Firm compaction, medium brown, clayey silt with moderate flints.	Subsoil Colluvium	0.3-0.4
1803	Mid orange brown, silty clay with moderate sub angular flints.	Natural Periglacial	0.3+
1804	White, soft chalk bedrock with moderate flint nodules. Undulating chalk surface.	Bedrock	0.3+

Trench 19	Dimensions: 28.8m x 1.8m Depth: 0.54m Trench alignment: WNW-ESE WNW-end Ground Level: 111.8m OD; ESE-end Ground Level: 111.37m OD Gap in trench for public footpath		
Context	Description	Interpretation	Depth (m)
1801	Firm compaction, Dark brownish grey, clayey silt, occ. flints.	Topsoil Ploughed soil	0.00-0.3
1802	Firm compaction, medium brown, clayey silt with moderate flints.	Subsoil Colluvium	0.3-0.4
1803	Mid orange brown, silty clay with moderate sub angular flints.	Natural Periglacial	0.4-0.5
1804	White, soft chalk bedrock with moderate flint nodules. Undulating chalk surface.	Bedrock	0.4+

Trench 20	Dimensions: 22.05m x 1.8m Depth: 0.42m Trench alignment: NNE-SSW NNE-end Ground Level: 111.42m OD; SSW-end Ground Level: 110.57m OD		
Context	Description	Interpretation	Depth (m)
2001	Firm compaction, Dark brownish grey, clayey silt, occ. flints.	Topsoil Ploughed soil	0.00-0.28
2002	Firm compaction, medium brown, clayey silt with moderate flints.	Subsoil Colluvium	0.28-0.38
2003	Mid orange brown, silty clay with moderate sub angular flints.	Natural Periglacial	0.38+
2004	White, soft chalk bedrock with moderate flint nodules. Undulating chalk surface.	Bedrock	0.38+

Trench 21	Dimensions: 24.8m x 1.8m Depth: 0.54m Trench alignment: WNW-ESE WNW-end Ground Level: 110.51m OD; ESE-end Ground Level: 110.08m OD		
-----------	---	--	--

	Gap in trench for public footpath		
Context	Description	Interpretation	Depth (m)
2101	Firm compaction, Dark brownish grey, clayey silt, occ. flints.	Topsoil Ploughed soil	0.00-0.3
2102	Firm compaction, medium brown, clayey silt with moderate flints.	Subsoil Colluvium	0.3+
[2103]	Large modern pit machine excavated to the depth of 0.9m. Hard deposit 2104 caused machine brake down.	Cut of modern pit	0.3-1.1+
2104	White, soft chalk bedrock with moderate flint nodules. Undulating chalk surface.	Fill of [2103]-backfill	0.3-0.9
2105	Very firm, light grey, clay.	Fill of [2103] - backfill	0.3-1.1

Trench 22	Dimensions: 22.9m x 1.8m Depth: 0.5m Trench alignment: NNE-SSW NNE-end Ground Level: 110.04m OD; SSW-end Ground Level: 109.61m OD		
Context	Description	Interpretation	Depth (m)
2201	Firm compaction, Dark brownish grey, clayey silt, occ. flints.	Topsoil Ploughed soil	0.00-0.3
2202	Firm compaction, medium brown, clayey silt with moderate flints.	Subsoil Colluvium	0.3-0.5
2203	Mid orange brown, silty clay with moderate sub angular flints.	Natural Periglacial	0.5+
2204	Very firm, light grey, clay – fill of large modern pit exposed in Trench 21.	Modern pit	0.3+

Trench 23	Dimensions: 29.6m x 1.8m Depth: 0.42m Trench alignment: WNW-ESE WNW-end Ground Level: 109.87m OD; ESE-end Ground Level: 109.67m OD		
Context	Description	Interpretation	Depth (m)
2301	Firm compaction, Dark brownish grey, clayey silt, occ. flints.	Topsoil Ploughed soil	0.00-0.3
2302	Firm compaction, medium brown, clayey silt with moderate flints.	Subsoil Colluvium	0.3-0.5
2303	Mid orange brown, silty clay with moderate sub angular flints.	Natural Periglacial	0.5-0.6
2304	White, soft chalk bedrock with moderate flint nodules. Undulating chalk surface.	Bedrock	0.5+

Trench 24	Dimensions: 29.7m x 1.8m Depth: 0.5m Trench alignment: NNE-SSW NNE-end Ground Level: 109.84m OD; SSW-end Ground Level: 109.49m OD		
Context	Description	Interpretation	Depth (m)
2401	Firm compaction, Dark brownish grey, clayey silt, occ. flints.	Topsoil Ploughed soil	0.00-0.3
2402	Firm compaction, medium brown, clayey silt with moderate flints.	Subsoil Colluvium	0.3-0.5
2403	Mid orange brown, silty clay with moderate sub angular flints.	Natural	0.5+

Trench 25	Dimensions: 29.7m x 1.8m Depth: 0.5m Trench alignment: WNW-ESE WNW-end Ground Level: 109.58m OD; ESE-end Ground Level: 109.38m OD		
Context	Description	Interpretation	Depth (m)

2501	Firm compaction, Dark brownish grey, clayey silt, occ. flints.	Topsoil Ploughed soil	0.00-0.3
2502	Firm compaction, medium brown, clayey silt with moderate flints.	Subsoil Colluvium	0.3-0.5
2503	Mid orange brown, silty clay with moderate sub angular flints.	Natural	0.5+

Trench 26	Dimensions: 28m x 1.8m Depth: 0.46m Trench alignment: NNE-SSW NNE-end Ground Level: 109.65m OD; SSW-end Ground Level: 109.27m OD		
Context	Description	Interpretation	Depth (m)
2601	Firm compaction, Dark brownish grey, clayey silt, occ. flints.	Topsoil Ploughed soil	0.00-0.3
2602	Firm compaction, medium brown, clayey silt with moderate flints.	Subsoil Colluvium	0.3-0.45
2603	Mid orange brown, silty clay with moderate sub angular flints.	Natural	0.45+

Trench 27	Dimensions: 29 m x 1.8m Depth: 0.4m Trench alignment: WNW-ESE WNW-end Ground Level: 109.45m OD; ESE-end Ground Level: 109.39m OD		
Context	Description	Interpretation	Depth (m)
2701	Firm compaction, Dark brownish grey, clayey silt, occ. flints.	Topsoil Ploughed soil	0.00-0.3
2702	Firm compaction, medium brown, clayey silt with moderate flints.	Subsoil Colluvium	0.3-0.4
2703	Mid orange brown, silty clay with moderate sub angular flints.	Natural	0.4+

Trench 28	Dimensions: 28m x 1.8m Depth: 0.42m Trench alignment: NNE-SSW NNE-end Ground Level: 109.7m OD; SSW-end Ground Level: 109.1m OD		
Context	Description	Interpretation	Depth (m)
2801	Firm compaction, Dark brownish grey, clayey silt, occ. flints.	Topsoil Ploughed soil	0.00-0.3
2802	Firm compaction, medium brown, clayey silt with moderate flints.	Subsoil Colluvium	0.3-0.4
2803	Mid orange brown, silty clay with moderate sub angular flints.	Natural	0.4+

Trench 29	Dimensions: 28m x 1.8m Depth: 0.45m Trench alignment: NNW-SSE NNW-end Ground Level: 109.59m OD; SSE-end Ground Level: 108.85m OD		
Context	Description	Interpretation	Depth (m)
2901	Firm compaction, Dark brownish grey, clayey silt, occ. flints.	Topsoil Ploughed soil	0.00-0.3
2902	Firm compaction, medium brown, clayey silt with moderate flints.	Subsoil Colluvium	0.3-0.45
2903	Mid orange brown, silty clay with moderate sub angular flints.	Natural	0.45+

12 APPENDIX 2 – HER FORM

Site Name: Archaeological Evaluation on Land at Tanyard Farm, Lenham, Kent

SWAT Site Code: LEN- EV-18

Site Address: As above

Summary: *Swale & Thames Survey Company (SWAT Archaeology) was commissioned by BDW Trading to undertake an archaeological evaluation on land at Tanyard Farm, Lenham, Kent. The archaeological programme was monitored by the Senior Archaeological Officer at Kent County Council. The Archaeological Evaluation consisted of 29 trenches, which recorded a relatively common stratigraphic sequence comprising topsoil and subsoil overlying natural geology. The fieldwork commenced on the 30th July 2018, being completed on the 8th August 2018.*

The archaeological evaluation has recorded the presence of a small enclosure dating to the late 3rd-4th century that has replaced a larger open field system that dates to the latter part of the 2nd century. An area within the southern extent of the site contains at least two floors, one on top of the other, that are formed around a series of structural post holes, in alignment, that were probably associated with a structure of some kind. The dating for the structure seems to favour late 2nd-3rd century so it is plausible to suggest a contemporary relationship with the open field system to the immediate north. In the event that finished ground levels remain constant, the depth of impact associated with future development is likely to require the excavation of material exceeding 0.50m in depth. It has been therefore recommended that further archaeological mitigation is focussed on targeted areas of excavation which can be carried out as part of a planning condition. The nature and scope of any further archaeological mitigation will need to be determined in consultation with the Senior Archaeological Advisor at Kent County Council.

District/Unitary: Maidstone Borough Council & Kent County Council

Period(s): Romano-British

NGR (centre of site to eight figures) NGR 590398 152149

Type of Archaeological work: Archaeological Evaluation

Date of recording: August 2018

Unit undertaking recording: Swale and Thames Survey Company (SWAT Archaeology)

Geology: West Melbury Marley Chalk Formation

Title and author of accompanying report: SWAT Archaeology (2018) Archaeological Evaluation on Land at Tanyard Farm, Lenham, Kent.

Location of archive/finds: SWAT. Archaeology. Graveney Rd, Faversham, Kent. ME13 8UP

Contact at Unit: Paul Wilkinson

Date: 18/08/2018

13 APPENDIX 3 – GEOPHYSICAL SURVEY REPORT (SUMO 2018)

GEOPHYSICAL SURVEY REPORT

sumo

Survey

GEOPHYSICS FOR
ARCHAEOLOGY &
ENGINEERING

Groom Way, Lenham, Kent

Client
SWAT Archaeology

Survey Report
13101

Date
August 2018

SUMO Geophysics Ltd
Cowburn Farm
Market Street
Thornton
Bradford
BD13 3HW
T: 01274 835016

SUMO Geophysics Ltd
Vineyard House
Upper Hook Road
Upton upon Severn
Worcestershire
WR8 0SA
T: 01684 592266

geophysics@sumoservices.com
www.sumoservices.com

GEOPHYSICAL SURVEY REPORT

Project name:
Groom Way, Lenham, Kent

SUMO Job reference:
13101

Client:
SWAT Archaeology

Survey date:
31 July 2018

Report date:
14 August 2018

Field co-ordinator:
David Stockwell BA

Field Team:
Aoife O'Reilly BA MSc
Haydn Evans BA

Report written by:
Rebecca Davies BSc

CAD illustrations by:
Rebecca Davies BSc

Project Manager:
Simon Haddrell BEng AMBCS PCIfA

Report approved by:
Dr John Gater BSc DSc(Hon) MCIfA FSA

TABLE OF CONTENTS

1	SUMMARY OF RESULTS	1
2	INTRODUCTION	1
3	METHODS, PROCESSING & PRESENTATION	2
4	RESULTS	3
5	DATA APPRAISAL & CONFIDENCE ASSESSMENT	4
6	CONCLUSION	4
7	REFERENCES	4

Appendix A Technical Information: Magnetometer Survey Method

Appendix B Technical Information: Magnetic Theory

LIST OF FIGURES

Figure 01	1:25 000	Site Location Diagram
Figure 02	1:1250	Location of Survey Area
Figure 03	1:1250	Magnetometer Survey - Greyscale Plot
Figure 04	1:1250	Magnetometer Survey - Interpretation
Figure 05	1:1250	Minimally Processed Data – Greyscale Plot

1 SUMMARY OF RESULTS

A detailed magnetometer survey was conducted over approximately 5.2 ha of arable farmland at Lenham, Kent. No definite archaeological anomalies have been identified, though possible ditch-type responses may be associated with the Romano-British site located immediately to the west. A modern track and evidence of ploughing are visible in the data, along with areas of natural magnetic variation and disturbance from nearby ferrous objects.

2 INTRODUCTION

2.1 Background synopsis

SUMO Geophysics Ltd were commissioned to undertake a geophysical survey of an area outlined for development. This survey forms part of an archaeological investigation being undertaken by **SWAT Archaeology**.

2.2 Site details

NGR / Postcode	TQ 902 522 / ME17 2QQ
Location	The site is located to the east of Lenham, Kent. Ashford Road forms the northern boundary of the site, with Groom Way to the west and Old Ashford Road to the south.
HER/SMR	Kent
District	Maidstone
Parish	Lenham CP
Topography	Mostly level
Current Land Use	Arable
Geology	Solid: West Melbury Marly Chalk Formation - chalk. Superficial: none recorded (BGS 2018).
Soils	Coombe 2 Association (511g) - well drained calcareous fine silty soils over chalk or chalk rubble (SSEW 1983).
Archaeology	The site lies in an area of archaeological potential. Romano-British activity is recorded immediately to the west, and may extend into the site (CAT 2015).
Survey Methods	Magnetometer survey (fluxgate gradiometer)
Study Area	5.2 ha

2.3 Aims and Objectives

To locate and characterise any anomalies of possible archaeological interest within the study area.

3 METHODS, PROCESSING & PRESENTATION

3.1 Standards & Guidance

This report and all fieldwork have been conducted in accordance with the latest guidance documents issued by Historic England (EH 2008) (then English Heritage), the Chartered Institute for Archaeologists (CIfA 2014) and the European Archaeological Council (EAC 2016).

3.2 Survey methods

Detailed magnetic survey was chosen as an efficient and effective method of locating archaeological anomalies.

Technique	Instrument	Traverse Interval	Sample Interval
Magnetometer	Bartington Grad 601-2	1.0m	0.25m

More information regarding this technique is included in Appendices A and B.

3.3 Data Processing

The following basic processing steps have been carried out on the data used in this report:

De-stripe; de-stagger; interpolate

3.4 Presentation of results and interpretation

The presentation of the results includes a 'minimally processed data' and a 'processed data' greyscale plot. Magnetic anomalies are identified, interpreted and plotted onto the 'Interpretation' drawings.

When interpreting the results, several factors are taken into consideration, including the nature of archaeological features being investigated and the local conditions at the site (geology, pedology, topography etc.). Anomalies are categorised by their potential origin. Where responses can be related to other existing evidence, the anomalies will be given specific categories, such as: *Abbey Wall* or *Roman Road*. Where the interpretation is based largely on the geophysical data, levels of confidence are implied, for example: *Probable*, or *Possible Archaeology*. The former is used for a confident interpretation, based on anomaly definition and/or other corroborative data such as cropmarks. Poor anomaly definition, a lack of clear patterns to the responses and an absence of other supporting data reduces confidence, hence the classification *Possible*.

4 RESULTS

Specific anomalies have been given numerical labels [1] [2] which appear in the text below, as well as on the Interpretation Figure.

4.1 **Probable / Possible Archaeology**

4.1.1 No magnetic responses have been recorded that could be interpreted as being of definite archaeological interest, however linear and discrete responses of possible archaeological origin are visible in the data. A ditch-like response [1] and other anomalies may have archaeological origins, given the immediate proximity of a known Romano-British site.

4.2 **Uncertain**

4.2.1 Two strong discrete areas of increased response [2] have been detected in the north of the area. These could be a result of shallow backfilled pits, though their interpretation as such is tentative. They are more likely to be of modern origin.

4.2.2 The origins of a small number of weak linear trends [3] in the south-west of the site is also unclear. They could be archaeological, natural or a result of modern agricultural activity; the small survey area hinders the interpretation.

4.3 **Track**

4.3.1 A linear anomaly, running approximately northeast-southwest across the west of the area is a result of a modern track.

4.4 **Agricultural – Ploughing**

4.4.1 Evidence of modern agricultural activity, such as ploughing, is visible across much of the site in the form of magnetically weak, closely spaced, parallel linear anomalies.

4.5 **Natural / Geological / Pedological / Topographic**

4.5.1 Sinuous bands of increased magnetic response can be seen across the site. These are likely to be natural in origin and may be indicative of former watercourses / palaeochannels.

4.6 **Ferrous / Magnetic Disturbance**

4.6.1 Ferrous responses close to boundaries are due to adjacent fences and gates. Smaller scale ferrous anomalies ("iron spikes") are present throughout the data and are characteristic of small pieces of ferrous debris (or brick / tile) in the topsoil; they are commonly assigned a modern origin. Only the most prominent of these are highlighted on the interpretation diagram.

5 DATA APPRAISAL & CONFIDENCE ASSESSMENT

- 5.1 Historic England guidelines (EH 2008) Table 4 states that the average magnetic response on chalk is generally good. The results from this survey indicate the presence of possible archaeological activity, along with evidence of modern ploughing and natural features. As a consequence, the technique is likely to have detected any archaeological features, if present.

6 CONCLUSION

- 6.1 The survey at Lenham has revealed no any anomalies of definite archaeological origin, however possible archaeological responses have been identified. These include ditch-like features and discrete anomalies, which may be associated with the Romano-British site recorded immediately to the west. A modern track and evidence of ploughing have been identified, along with sinuous bands of natural magnetic variation.

7 REFERENCES

- BGS 2018 British Geological Survey, Geology of Britain viewer [Accessed 14/08/2018] *website:* (<http://www.bgs.ac.uk/opengeoscience/home.html?Accordion1=1#maps>)
- CAT 2015 *Ashford Road, Lenham, Kent. Desk-Based Assessment.* Canterbury Archaeological Trust; unpublished report.
- ClfA 2014 *Standard and Guidance for Archaeological Geophysical Survey.* Amended 2016. ClfA Guidance note. Chartered Institute for Archaeologists, Reading
http://www.archaeologists.net/sites/default/files/ClfAS%26GGeophysics_2.pdf
- EAC 2016 *EAC Guidelines for the Use of Geophysics in Archaeology,* European Archaeological Council, Guidelines 2.
- EH 2008 *Geophysical Survey in Archaeological Field Evaluation.* English Heritage, Swindon
<https://content.historicengland.org.uk/images-books/publications/geophysical-survey-in-archaeological-field-evaluation/geophysics-guidelines.pdf/>
- SSEW 1983 *Soils of England and Wales. Sheet 6, South East England.* Soil Survey of England and Wales, Harpenden.

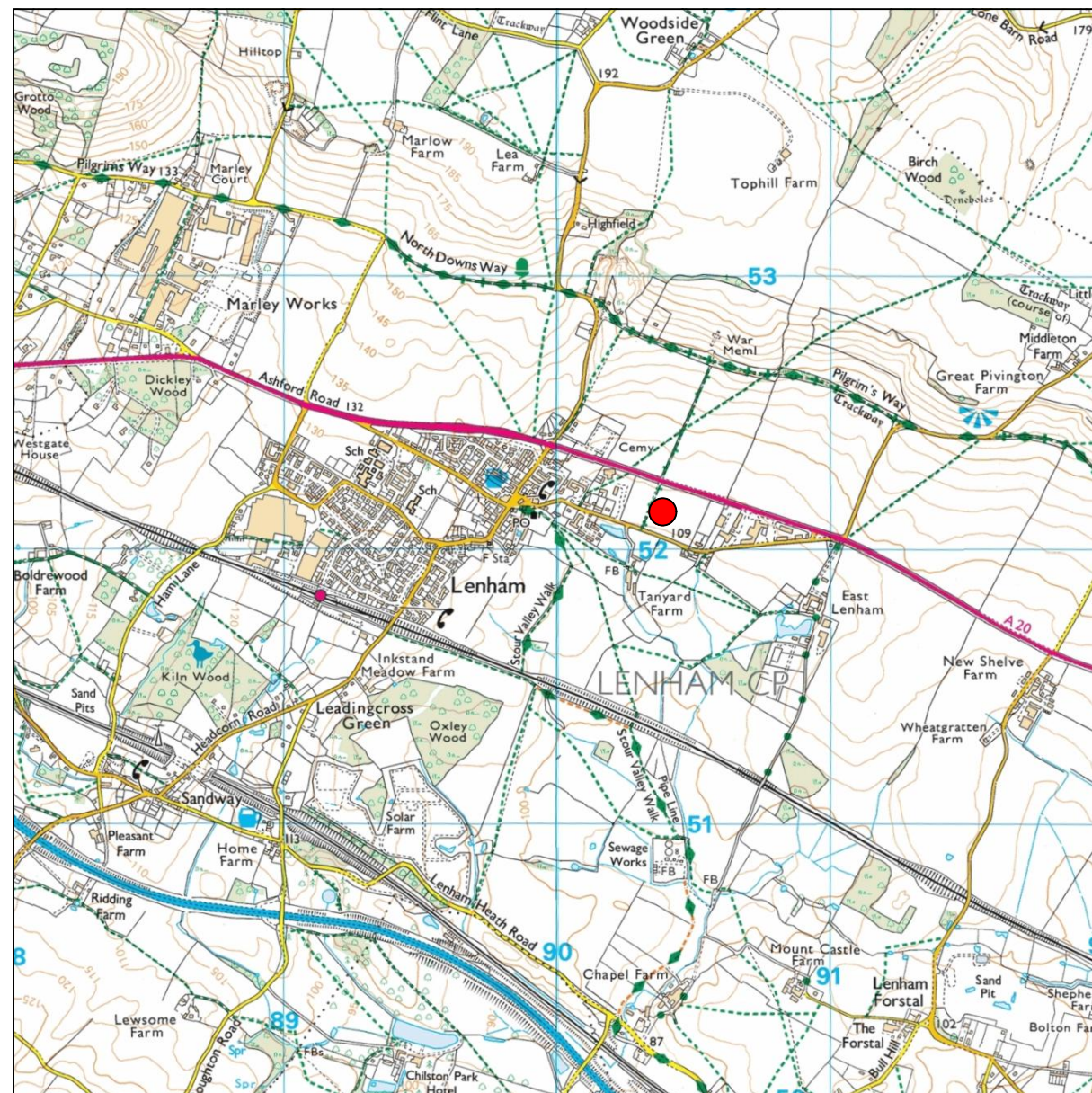

 Site Location

Reproduced from Ordnance Survey's 1:25 000 map of 1998 with the permission of the controller of Her Majesty's Stationery Office.
Crown Copyright reserved.
Licence No: 100018665

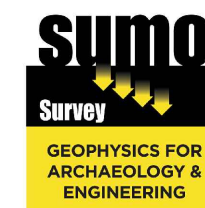

Title: Site Location Diagram

Client: SWAT Archaeology

Project: 13101 - Groom Way, Lenham, Kent

Scale: 
1:25000 @ A3

Fig No: 01



 Survey Area - showing 30m grid

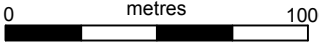
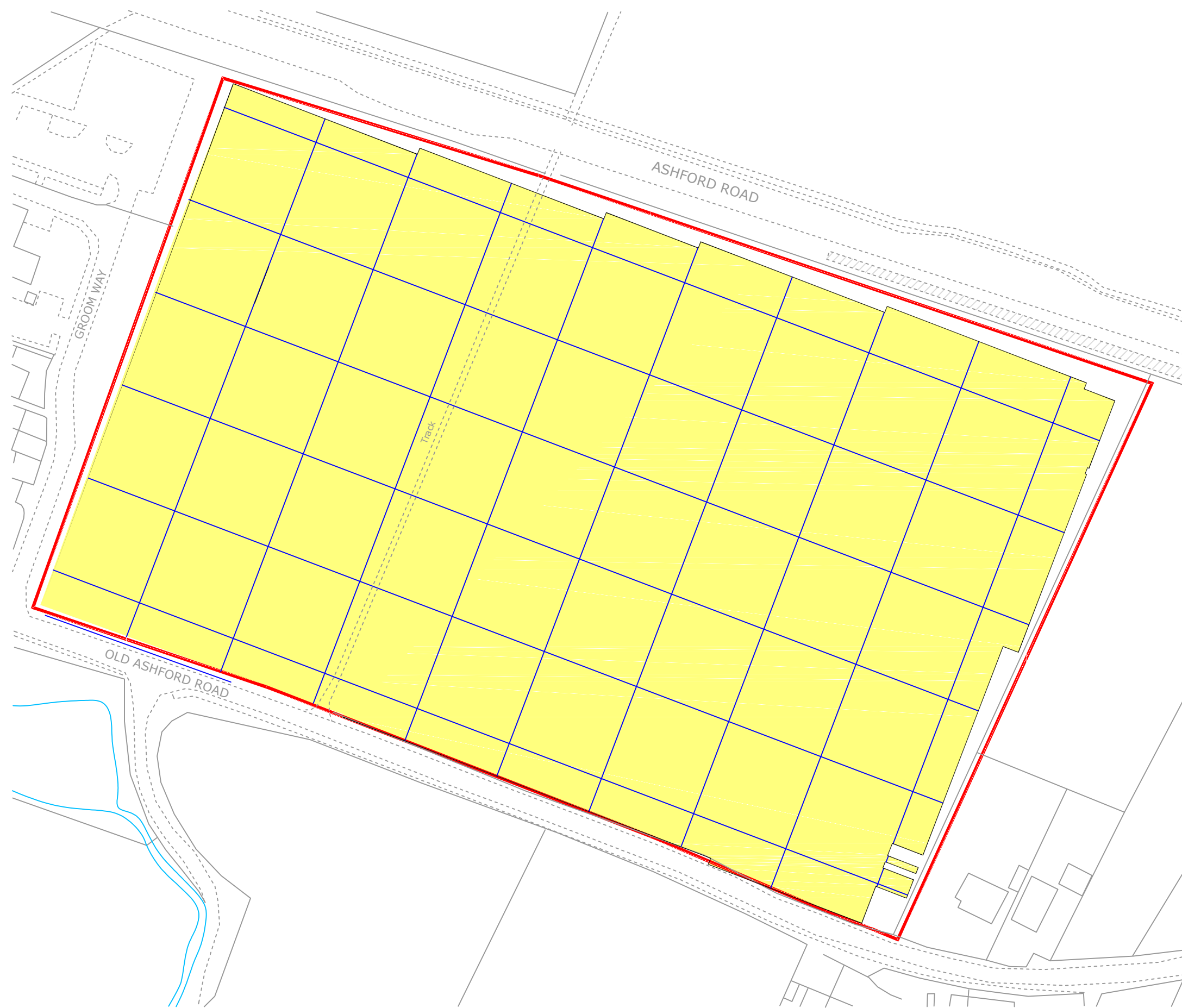
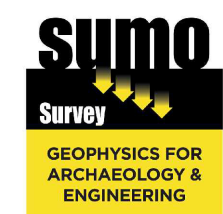

Title: Location of Survey Area

Client: SWAT Archaeology

Project: 13101 - Groom Way, Lenham, Kent

Scale:  1:1250 @ A3

Fig No: 02



Title: Magnetometer Survey - Greyscale Plots

Client: SWAT Archaeology

Project: 13101 - Groom Way, Lenham, Kent

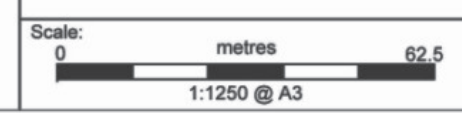
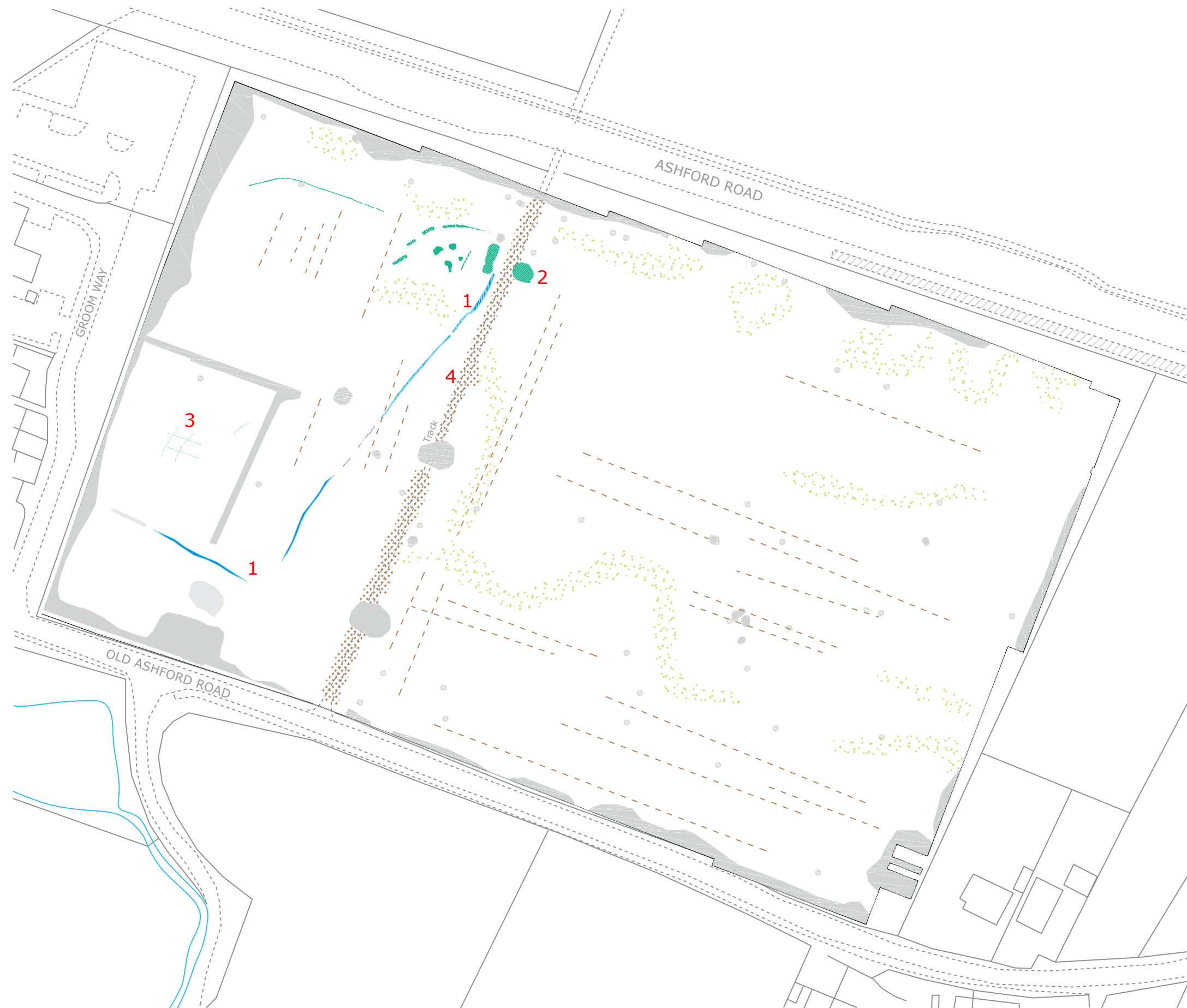





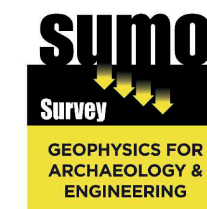

Fig No: 03



KEY

	Possible archaeology (discrete anomaly / trend)
	Uncertain Origin (discrete anomaly / trend)
	Agriculture (plough)
	Track (modern)
	Natural (e.g. geological / pedological)
	Ferrous



Title: Magnetometer Survey - Interpretation

Client: SWAT Archaeology

Project: 13101 - Groom Way, Lenham, Kent

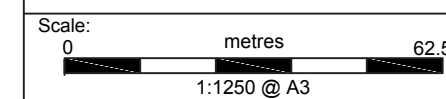
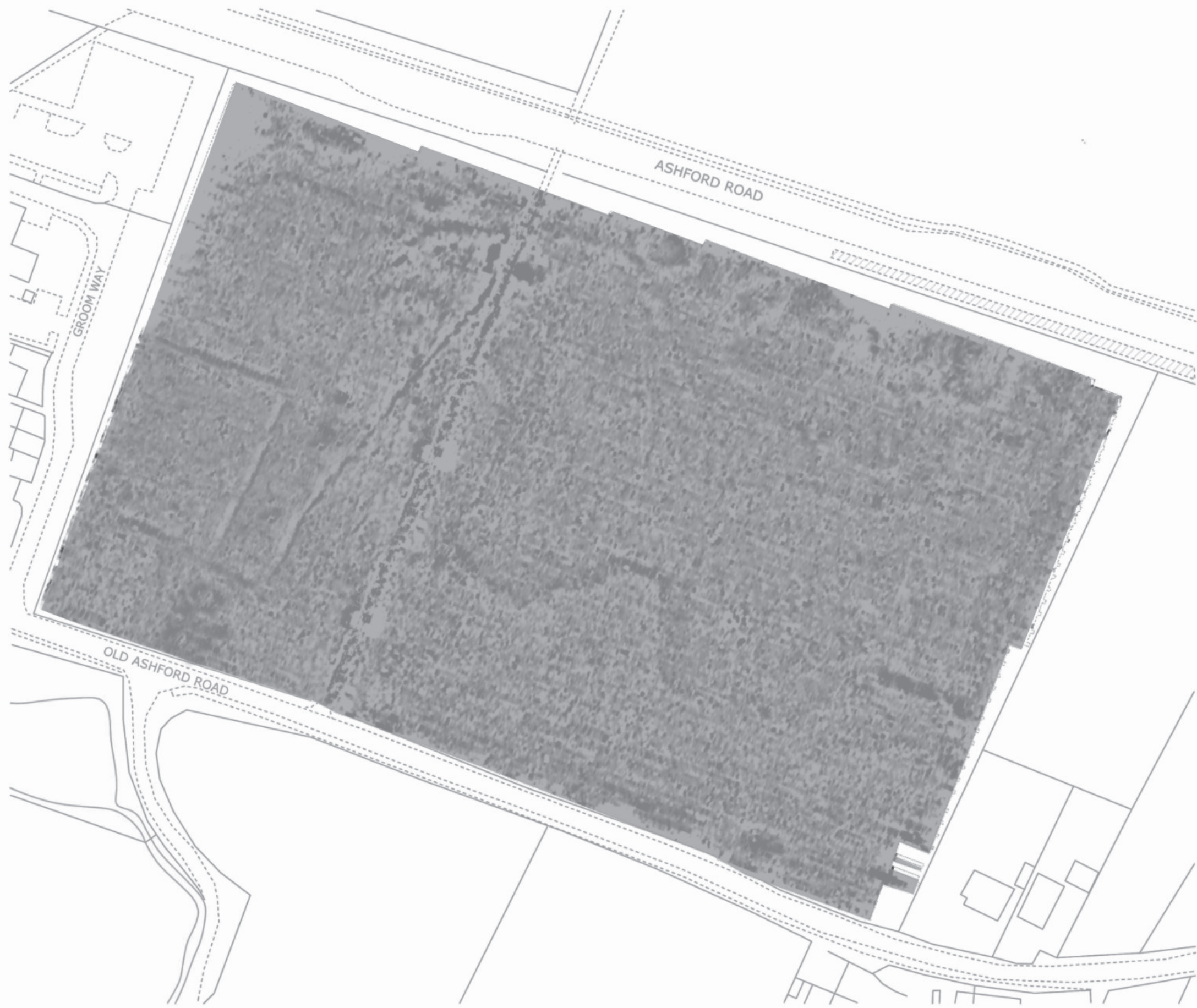

Fig No: 04



Title:
Minimally Processed Data - Greyscale Plot

Client:
SWAT Archaeology

Project:
13101 - Groom Way, Lenham, Kent

Scale:
0 metres 62.5
1:1250 @ A3

Fig No:
05

Appendix A - Technical Information: Magnetometer Survey Method

Grid Positioning

For hand held gradiometers the location of the survey grids has been plotted together with the referencing information. Grids were set out using a Trimble R8 Real Time Kinematic (RTK) VRS Now GNSS GPS system.

An RTK GPS (Real-time Kinematic Global Positioning System) can locate a point on the ground to a far greater accuracy than a standard GPS unit. A standard GPS suffers from errors created by satellite orbit errors, clock errors and atmospheric interference, resulting in an accuracy of 5m-10m. An RTK system uses a single base station receiver and a number of mobile units. The base station re-broadcasts the phase of the carrier it measured, and the mobile units compare their own phase measurements with those they received from the base station. This results in an accuracy of around 0.01m.

Technique	Instrument	Traverse Interval	Sample Interval
Magnetometer	Bartington Grad 601-2	1m	0.25m

Instrumentation: **Bartington Grad 601-2**

Bartington instruments operate in a gradiometer configuration which comprises fluxgate sensors mounted vertically, set 1.0m apart. The fluxgate gradiometer suppresses any diurnal or regional effects. The instruments are carried, or cart mounted, with the bottom sensor approximately 0.1-0.3m from the ground surface. At each survey station, the difference in the magnetic field between the two fluxgates is measured in nanoTesla (nT). The sensitivity of the instrument can be adjusted; for most archaeological surveys the most sensitive range (0.1nT) is used. Generally, features up to 1m deep may be detected by this method, though strongly magnetic objects may be visible at greater depths. The Bartington instrument can collect two lines of data per traverse with gradiometer units mounted laterally with a separation of 1.0m. The readings are logged consecutively into the data logger which in turn is daily down-loaded into a portable computer whilst on site. At the end of each site survey, data is transferred to the office for processing and presentation.

Data Processing

Zero Mean Traverse	This process sets the background mean of each traverse within each grid to zero. The operation removes striping effects and edge discontinuities over the whole of the data set.
Step Correction (De-stagger)	When gradiometer data are collected in 'zig-zag' fashion, stepping errors can sometimes arise. These occur because of a slight difference in the speed of walking on the forward and reverse traverses. The result is a staggered effect in the data, which is particularly noticeable on linear anomalies. This process corrects these errors.

Display

Greyscale/ Colourscale Plot	This format divides a given range of readings into a set number of classes. Each class is represented by a specific shade of grey, the intensity increasing with value. All values above the given range are allocated the same shade (maximum intensity); similarly, all values below the given range are represented by the minimum intensity shade. Similar plots can be produced in colour, either using a wide range of colours or by selecting two or three colours to represent positive and negative values. The assigned range (plotting levels) can be adjusted to emphasise different anomalies in the data-set.
--------------------------------	---

Interpretation Categories

In certain circumstances (usually when there is corroborative evidence from desk-based or excavation data) very specific interpretations can be assigned to magnetic anomalies (for example, *Roman Road, Wall, etc.*) and where appropriate, such interpretations will be applied. The list below outlines the generic categories commonly used in the interpretation of the results.

<i>Archaeology / Probable Archaeology</i>	This term is used when the form, nature and pattern of the responses are clearly or very probably archaeological and /or if corroborative evidence is available. These anomalies, whilst considered anthropogenic, could be of any age.
<i>Possible Archaeology</i>	These anomalies exhibit either weak signal strength and / or poor definition, or form incomplete archaeological patterns, thereby reducing the level of confidence in the interpretation. Although the archaeological interpretation is favoured, they may be the result of variable soil depth, plough damage or even aliasing as a result of data collection orientation.
<i>Industrial / Burnt-Fired</i>	Strong magnetic anomalies that, due to their shape and form or the context in which they are found, suggest the presence of kilns, ovens, corn dryers, metal-working areas or hearths. It should be noted that in many instances modern ferrous material can produce similar magnetic anomalies.
<i>Former Field Boundary (probable & possible)</i>	Anomalies that correspond to former boundaries indicated on historic mapping, or which are clearly a continuation of existing land divisions. Possible denotes less confidence where the anomaly may not be shown on historic mapping but nevertheless the anomaly displays all the characteristics of a field boundary.
<i>Ridge & Furrow</i>	Parallel linear anomalies whose broad spacing suggests ridge and furrow cultivation. In some cases, the response may be the result of more recent agricultural activity.
<i>Agriculture (ploughing)</i>	Parallel linear anomalies or trends with a narrower spacing, sometimes aligned with existing boundaries, indicating more recent cultivation regimes.
<i>Land Drain</i>	Weakly magnetic linear anomalies, quite often appearing in series forming parallel and herringbone patterns. Smaller drains may lead and empty into larger diameter pipes, which in turn usually lead to local streams and ponds. These are indicative of clay fired land drains.
<i>Natural</i>	These responses form clear patterns in geographical zones where natural variations are known to produce significant magnetic distortions.
<i>Magnetic Disturbance</i>	Broad zones of strong dipolar anomalies, commonly found in places where modern ferrous or fired materials (e.g. brick rubble) are present. They are presumed to be modern.
<i>Service</i>	Magnetically strong anomalies, usually forming linear features are indicative of ferrous pipes/cables. Sometimes other materials (e.g. pvc) or the fill of the trench can cause weaker magnetic responses which can be identified from their uniform linearity.
<i>Ferrous</i>	This type of response is associated with ferrous material and may result from small items in the topsoil, larger buried objects such as pipes, or above ground features such as fence lines or pylons. Ferrous responses are usually regarded as modern. Individual burnt stones, fired bricks or igneous rocks can produce responses similar to ferrous material.
<i>Uncertain Origin</i>	Anomalies which stand out from the background magnetic variation, yet whose form and lack of patterning gives little clue as to their origin. Often the characteristics and distribution of the responses straddle the categories of <i>Possible Archaeology / Natural</i> or (in the case of linear responses) <i>Possible Archaeology / Agriculture</i> ; occasionally they are simply of an unusual form.

Where appropriate some anomalies will be further classified according to their form (positive or negative) and relative strength and coherence (trend: weak and poorly defined).

Appendix B - Technical Information: Magnetic Theory

Detailed magnetic survey can be used to effectively define areas of past human activity by mapping spatial variation and contrast in the magnetic properties of soil, subsoil and bedrock. Although the changes in the magnetic field resulting from differing features in the soil are usually weak, changes as small as 0.1 nanoTeslas (nT) in an overall field strength of 48,000 (nT), can be accurately detected.

Weakly magnetic iron minerals are always present within the soil and areas of enhancement relate to increases in *magnetic susceptibility* and permanently magnetised *thermoremanent* material.

Magnetic susceptibility relates to the induced magnetism of a material when in the presence of a magnetic field. This magnetism can be considered as effectively permanent as it exists within the Earth's magnetic field. Magnetic susceptibility can become enhanced due to burning and complex biological or fermentation processes.

Thermoremanence is a permanent magnetism acquired by iron minerals that, after heating to a specific temperature known as the Curie Point, are effectively demagnetised followed by re-magnetisation by the Earth's magnetic field on cooling. Thermoremanent archaeological features can include hearths and kilns; material such as brick and tile may be magnetised through the same process.

Silting and deliberate infilling of ditches and pits with magnetically enhanced soil creates a relative contrast against the much lower levels of magnetism within the subsoil into which the feature is cut. Systematic mapping of magnetic anomalies will produce linear and discrete areas of enhancement allowing assessment and characterisation of subsurface features. Material such as subsoil and non-magnetic bedrock used to create former earthworks and walls may be mapped as areas of lower enhancement compared to surrounding soils.

Magnetic survey is carried out using a fluxgate gradiometer which is a passive instrument consisting of two sensors mounted vertically 1m apart. The instrument is carried about 30cm above the ground surface and the top sensor measures the Earth's magnetic field whilst the lower sensor measures the same field but is also more affected by any localised buried feature. The difference between the two sensors will relate to the strength of a magnetic field created by this feature, if no field is present the difference will be close to zero as the magnetic field measured by both sensors will be the same.

Factors affecting the magnetic survey may include soil type, local geology, previous human activity and disturbance from modern services.

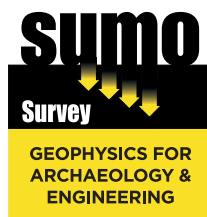

- Archaeological
- Geophysical
- Laser Scanning
- Measured Building
- Topographic
- Utility Mapping

SUMO Services Ltd, incorporated under the laws of England and Wales,
Company Registration No.4275993.
Registered Office Unit 8 Hayward Business Centre, New Lane, Havant, Hampshire, PO9 2NL

FIGURES

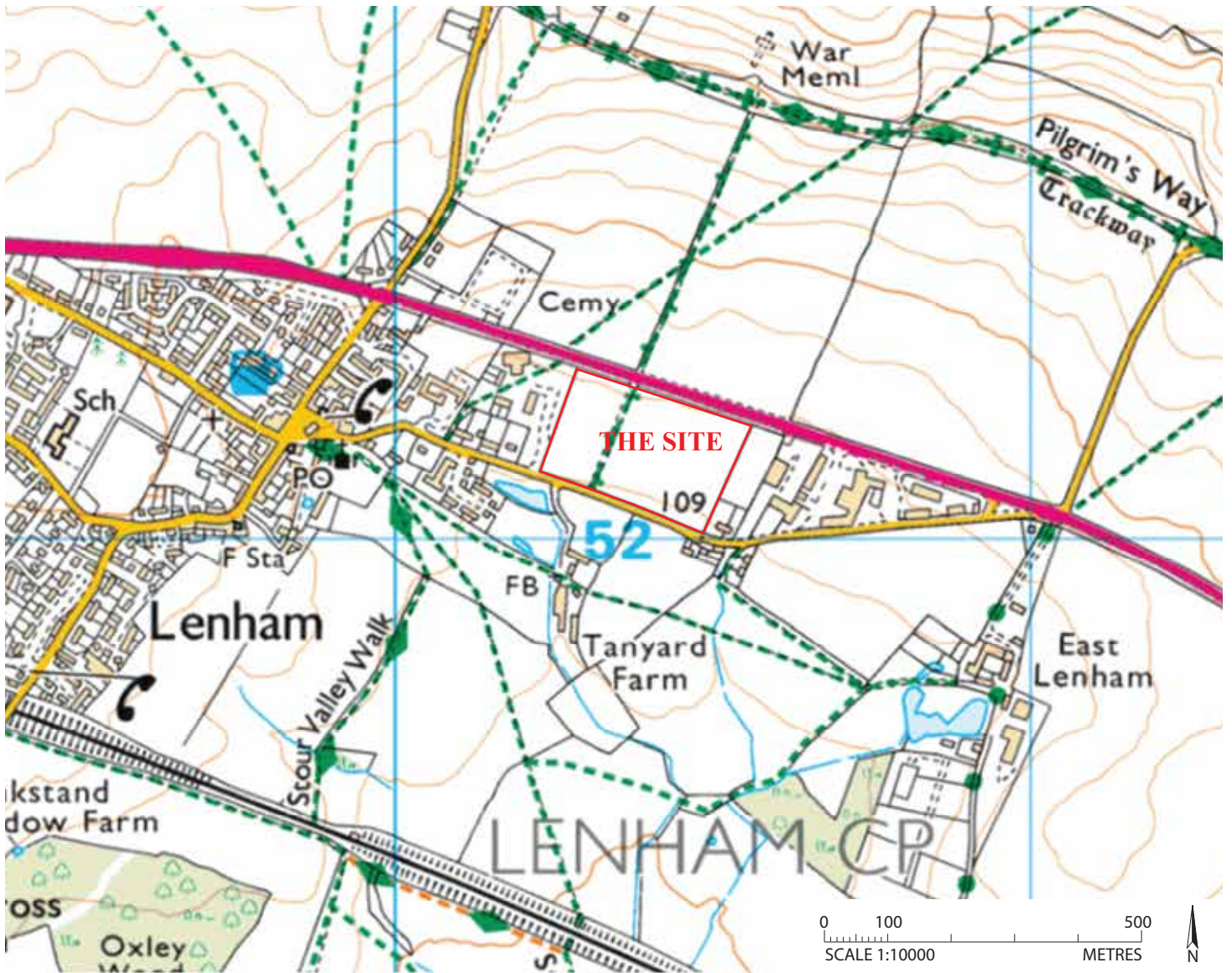

Figure 1: Site location map, scale 1:10000.

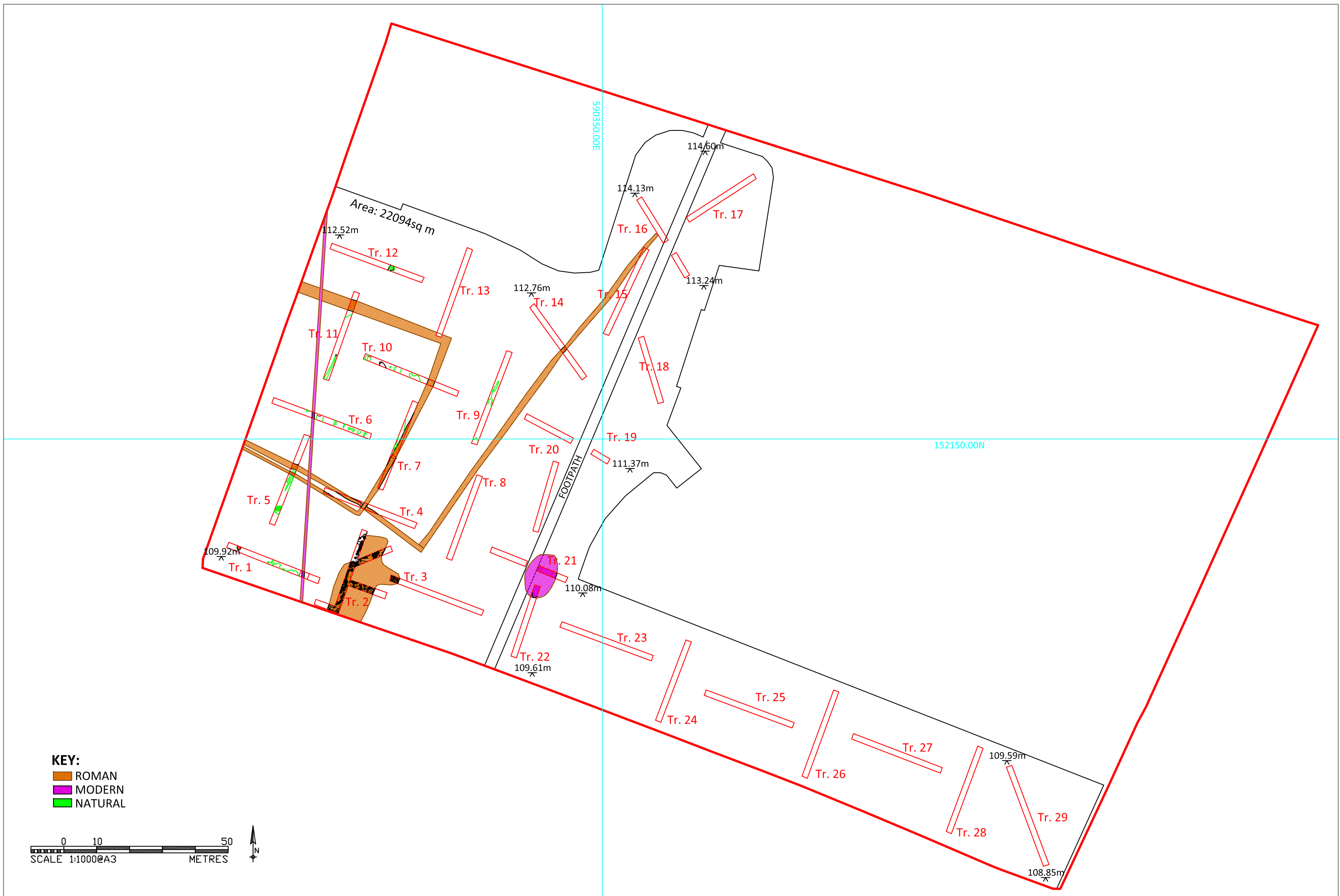

Figure 2: Lenham, Evaluation trenches - Phase 1

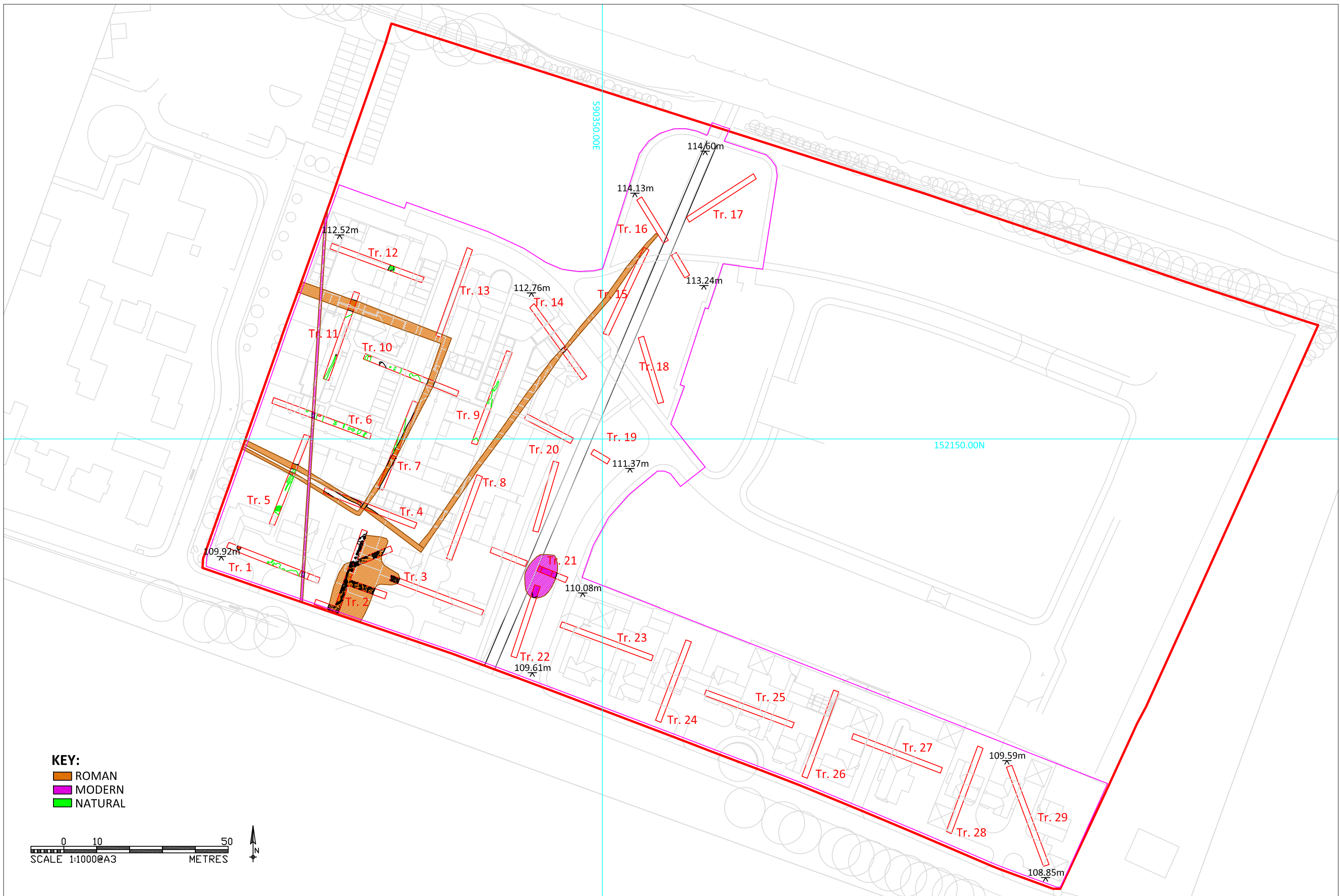

Figure 3: Lenham, Evaluation trenches - phase 1 in relation to development



Figure 4: Lenham, Extrapolated features exposed in evaluation trenches - phase 1 in relation to geophysical survey



Figure 4a: Lenham, Features exposed in evaluation trenches - phase 1 in relation to geophysical survey

Tr. 1

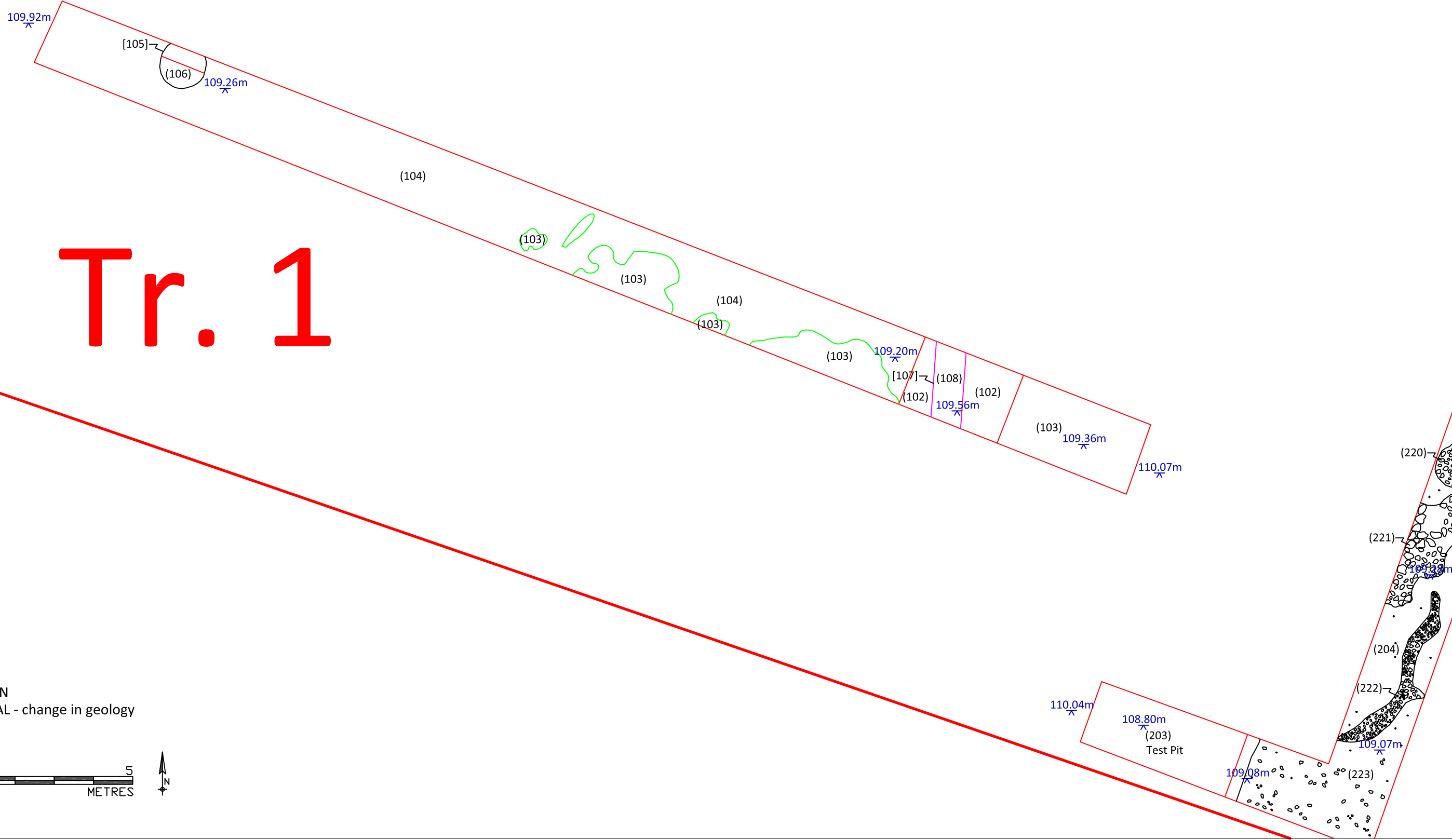

Figure 5: Lenham, Evaluation phase 1 - Trench 1

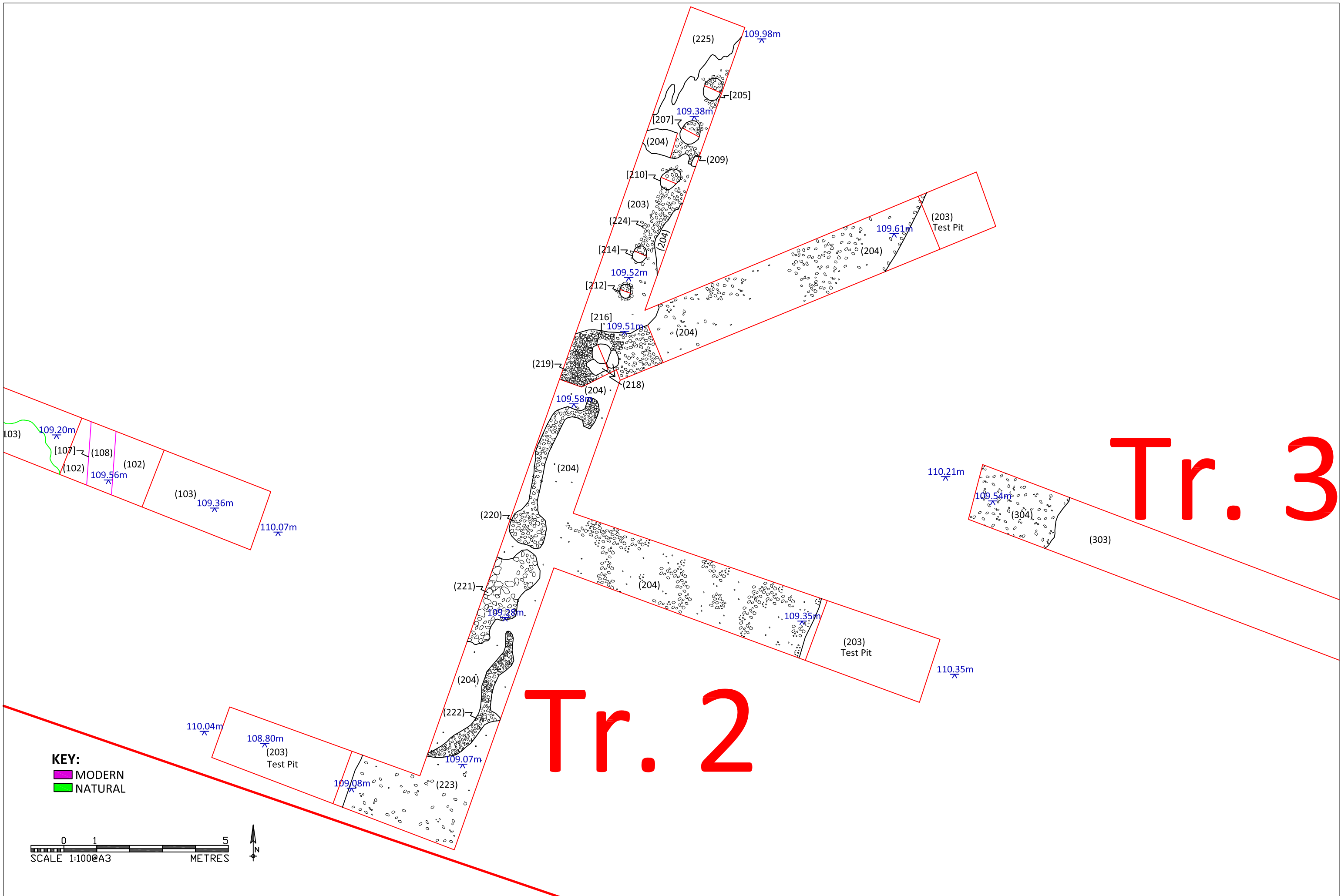

Figure 6: Lenham, Evaluation phase 1 - Trench 2

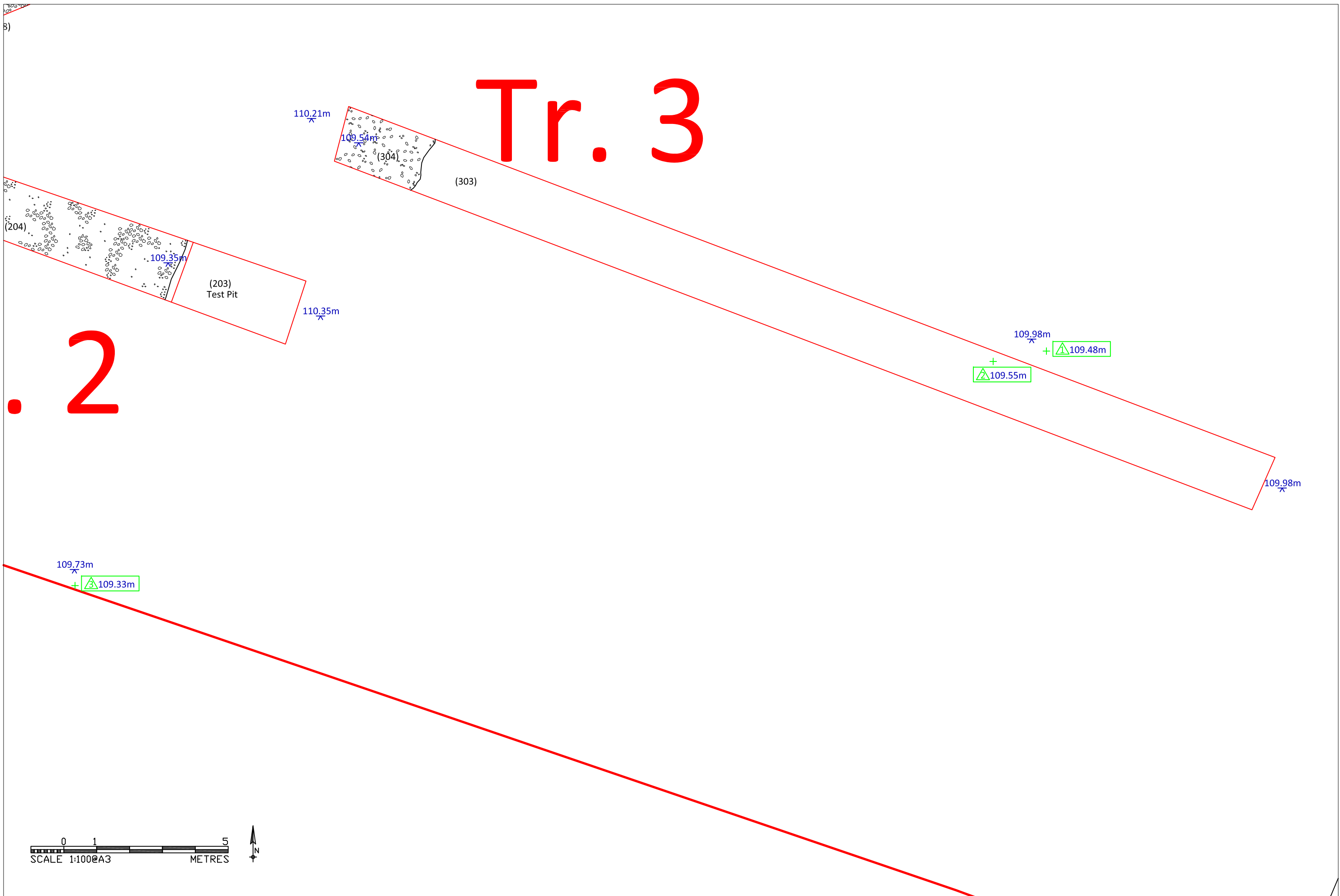

Figure 7: Lenham, Evaluation phase 1 - Trench 3

Tr. 7

Tr. 4

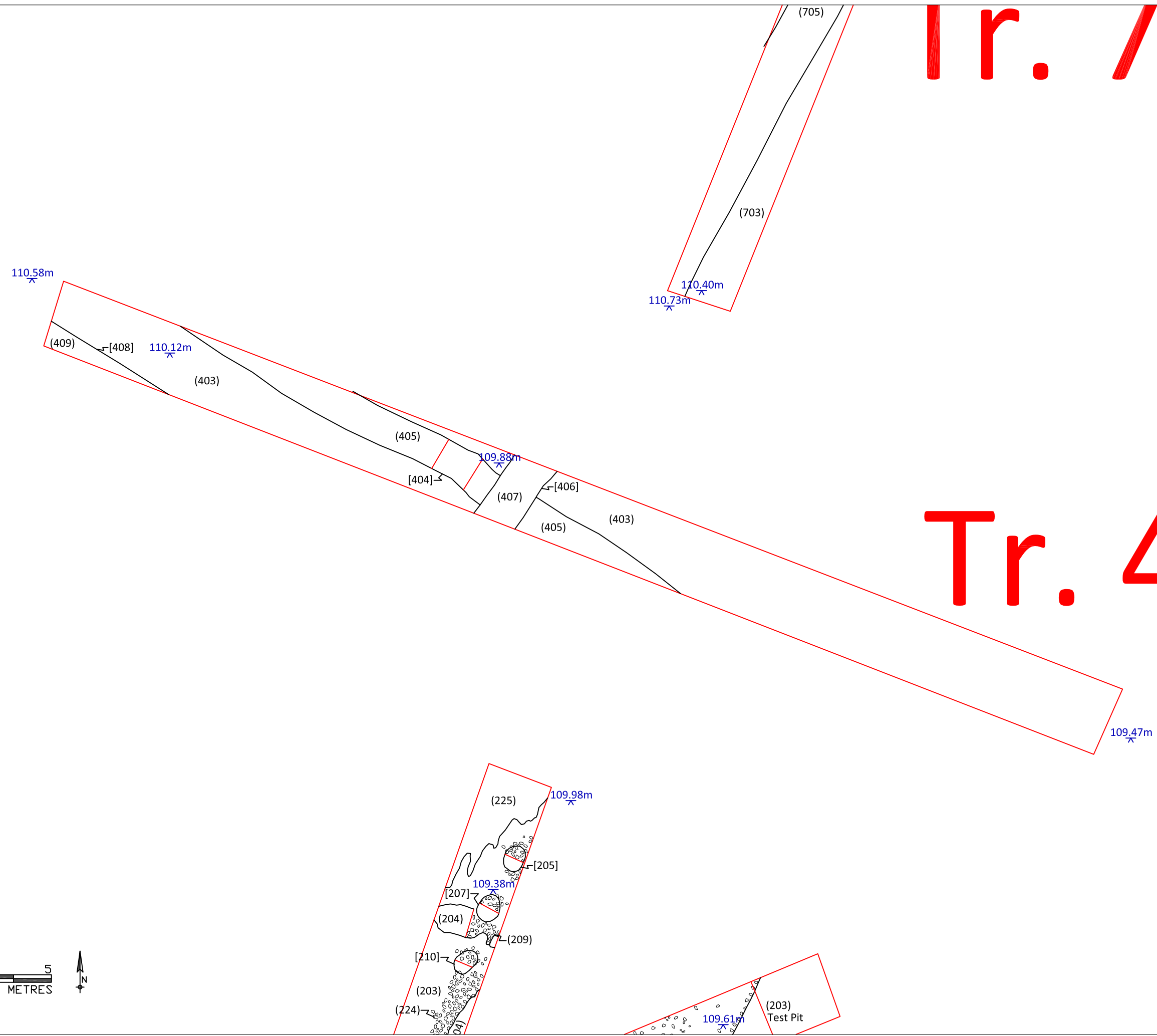

Figure 8: Lenham, Evaluation phase 1 - Trench 4

Tr. 5

KEY:
■ NATURAL

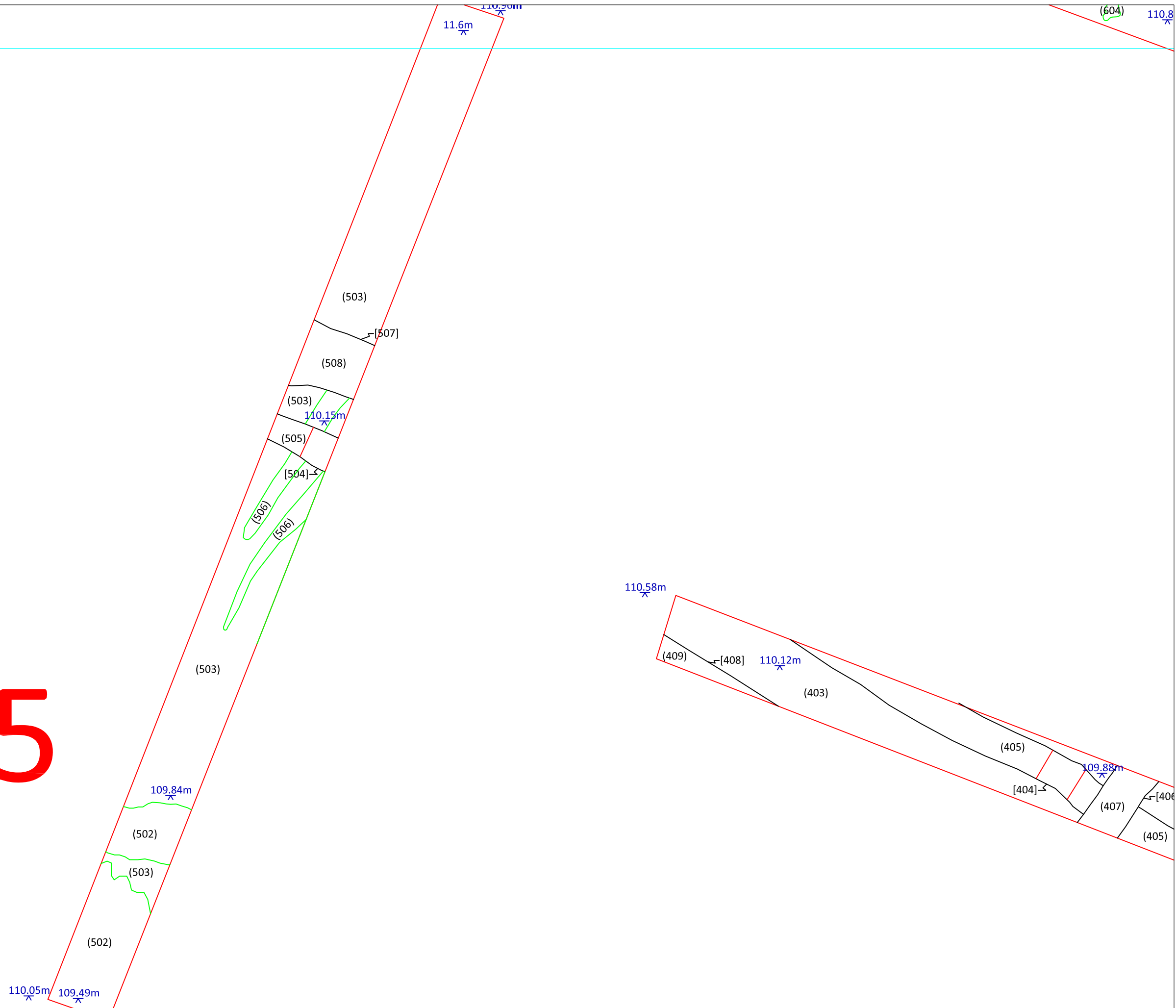

Figure 9: Lenham, Evaluation phase 1 - Trench 5

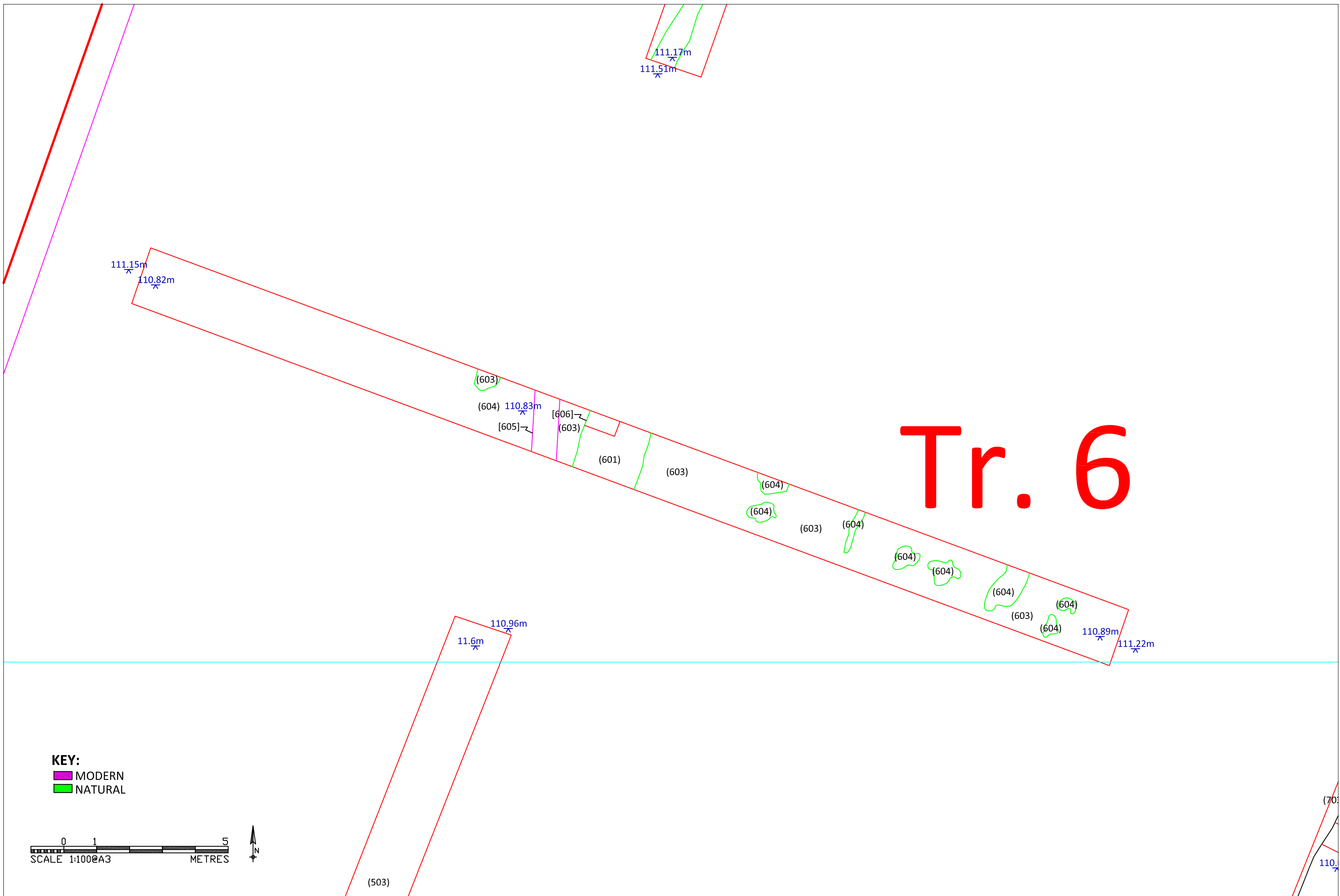
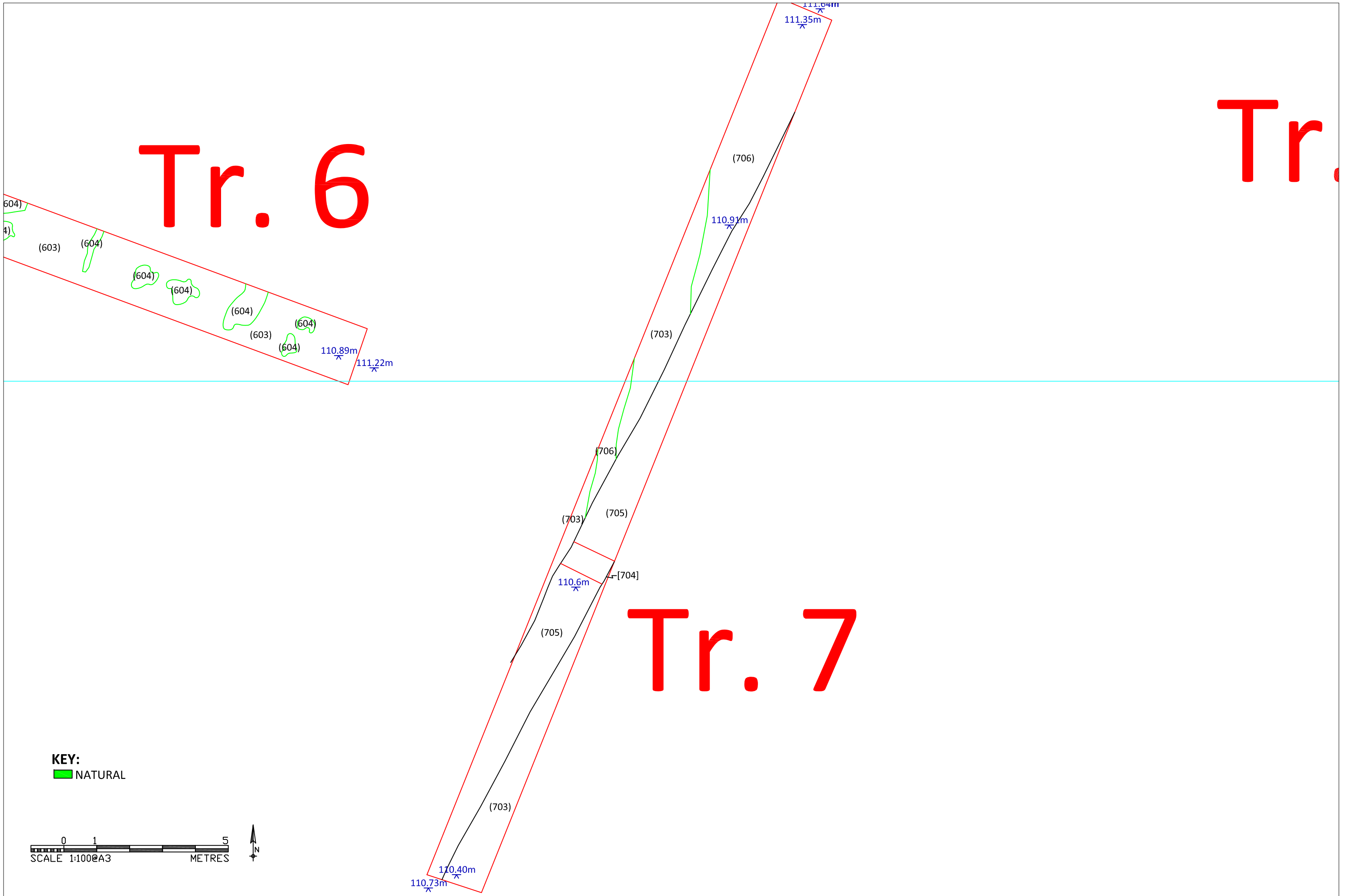

Figure 10: Lenham, Evaluation phase 1 - Trench 6

Tr. 6

Tr.



KEY:
■ NATURAL

0 1 5
SCALE 1:100@A3 METRES



Figure: Lenham, Evaluation phase 1 - Trench 7

Tr. 10

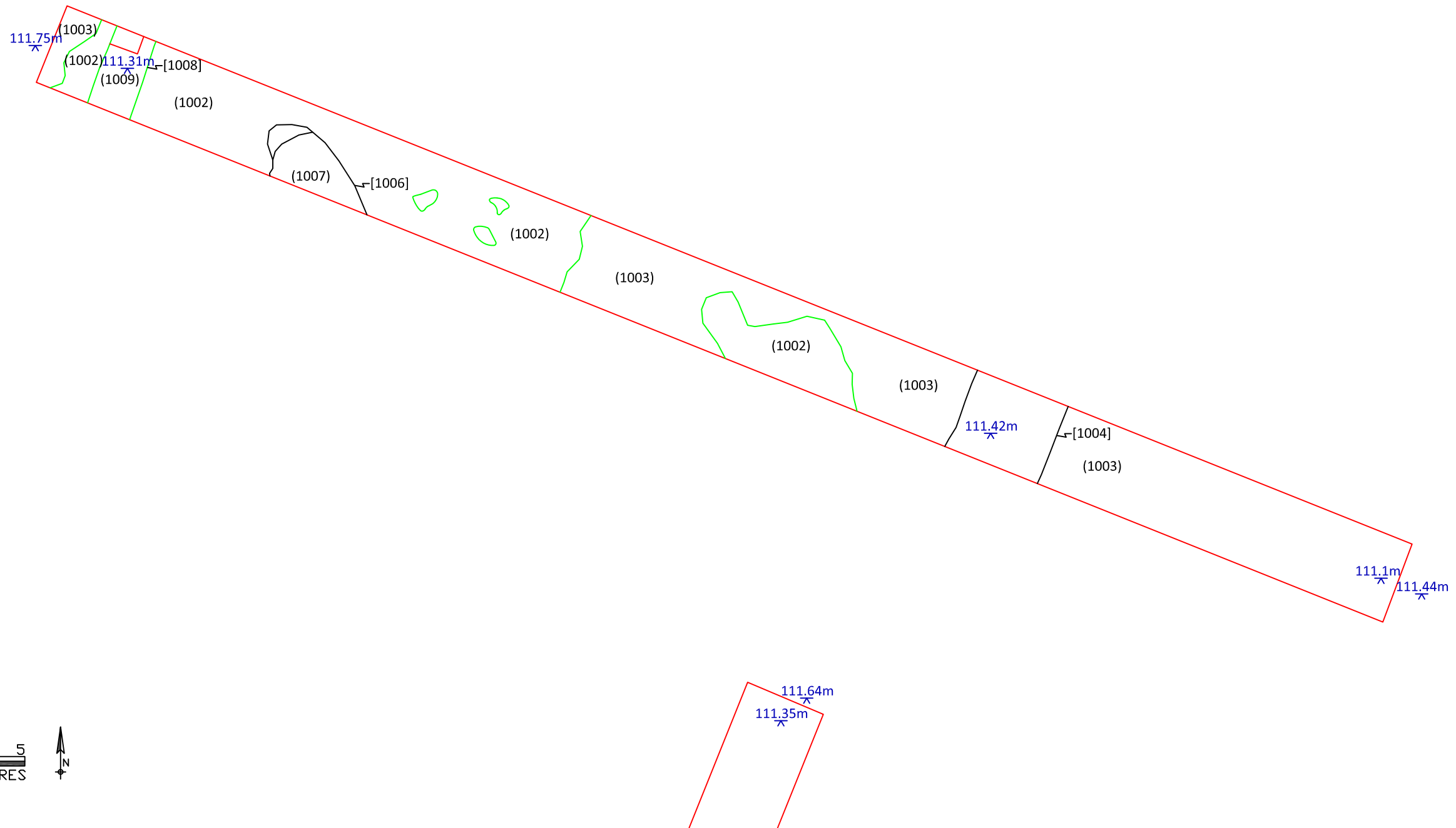

Figure 12: Lenham, Evaluation phase 1 - Trench 10

Tr. 11

Tr. 10

KEY:
■ NATURAL

0 1 5
SCALE 1:100@A3 METRES

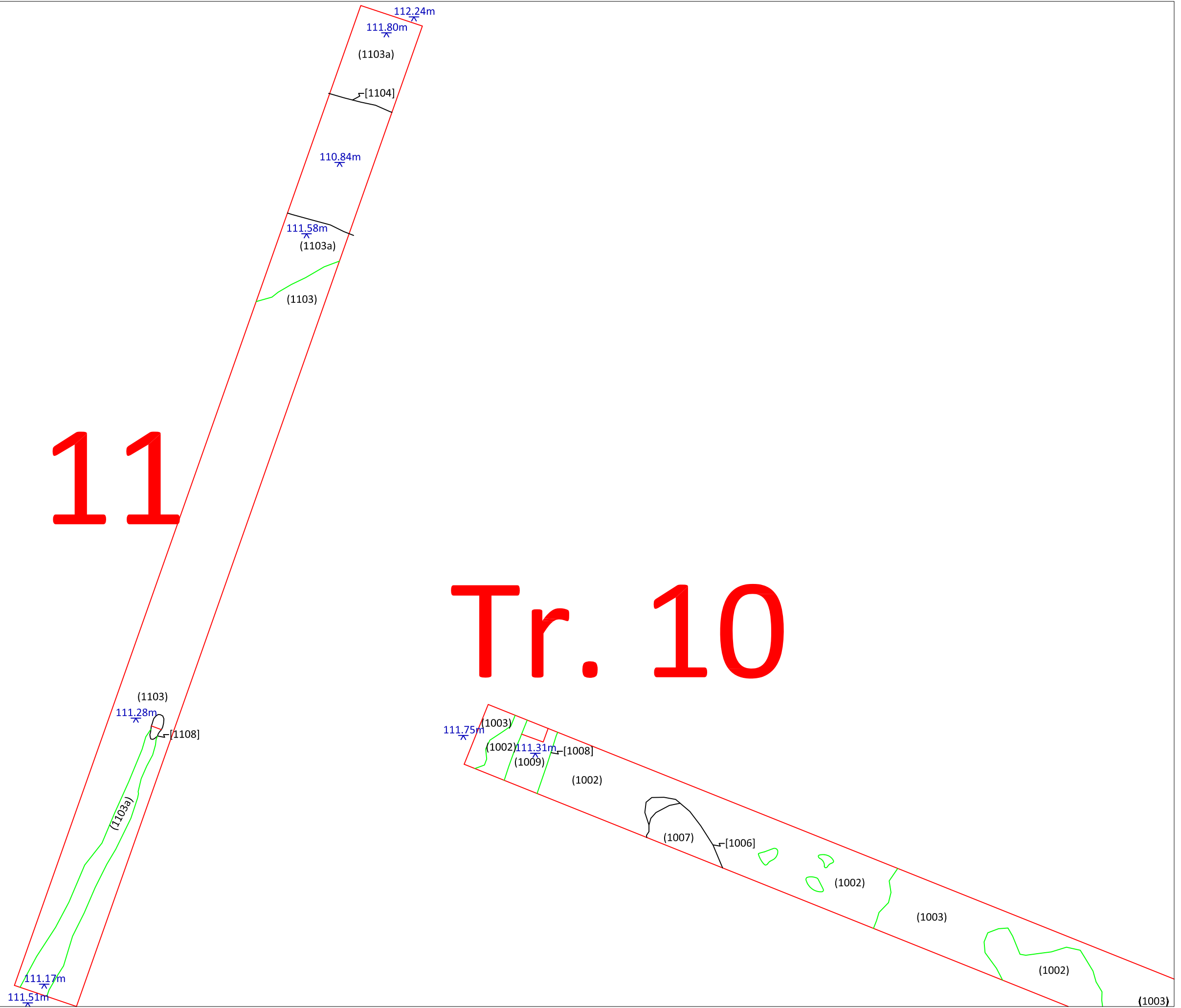
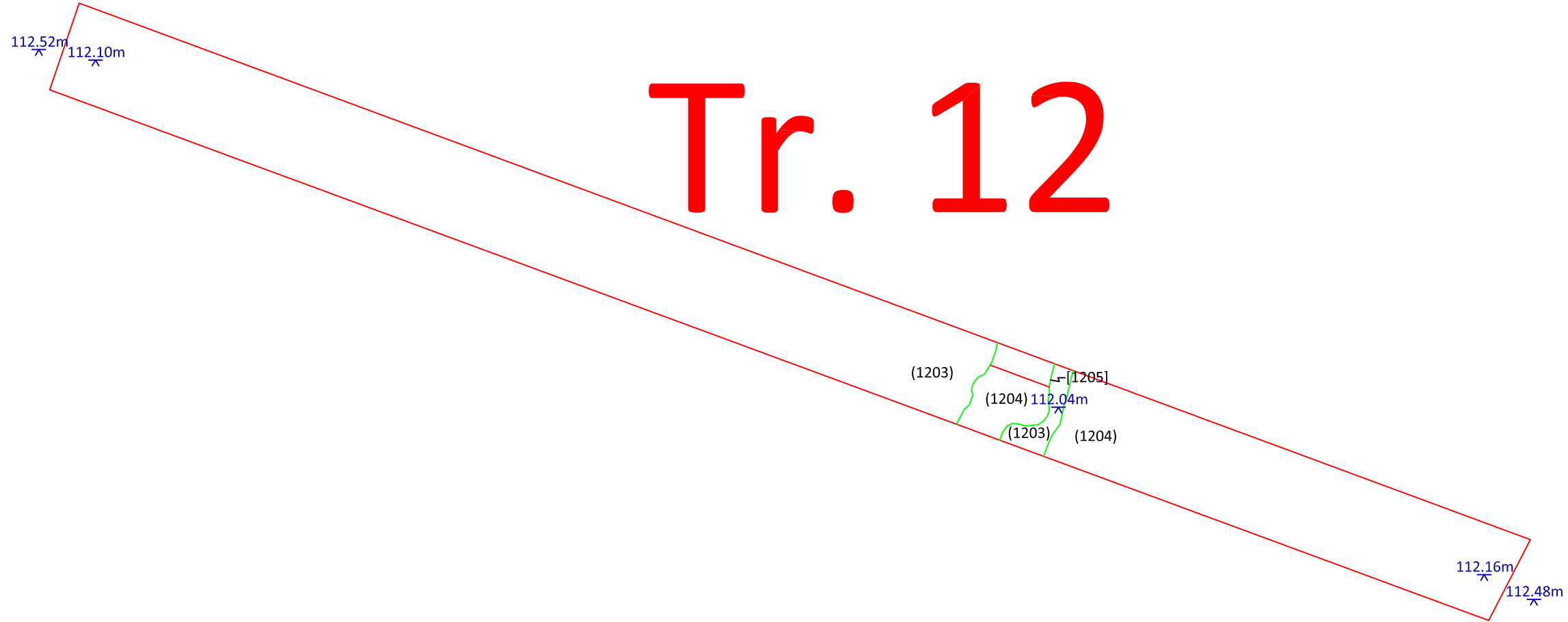

Figure 13: Lenham, Evaluation phase 1 - Trench 11

Tr. 12



KEY:
■ NATURAL

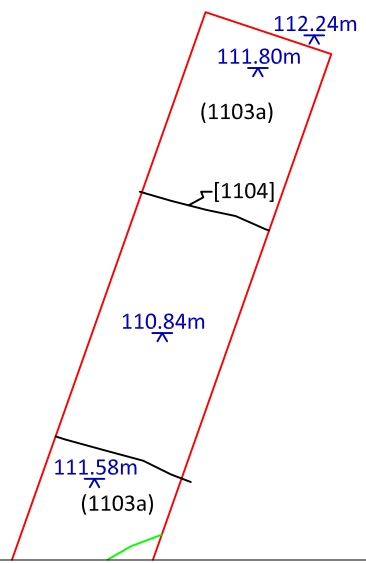

Figure 14: Lenham, Evaluation phase 1 - Trench 12

Tr. 14

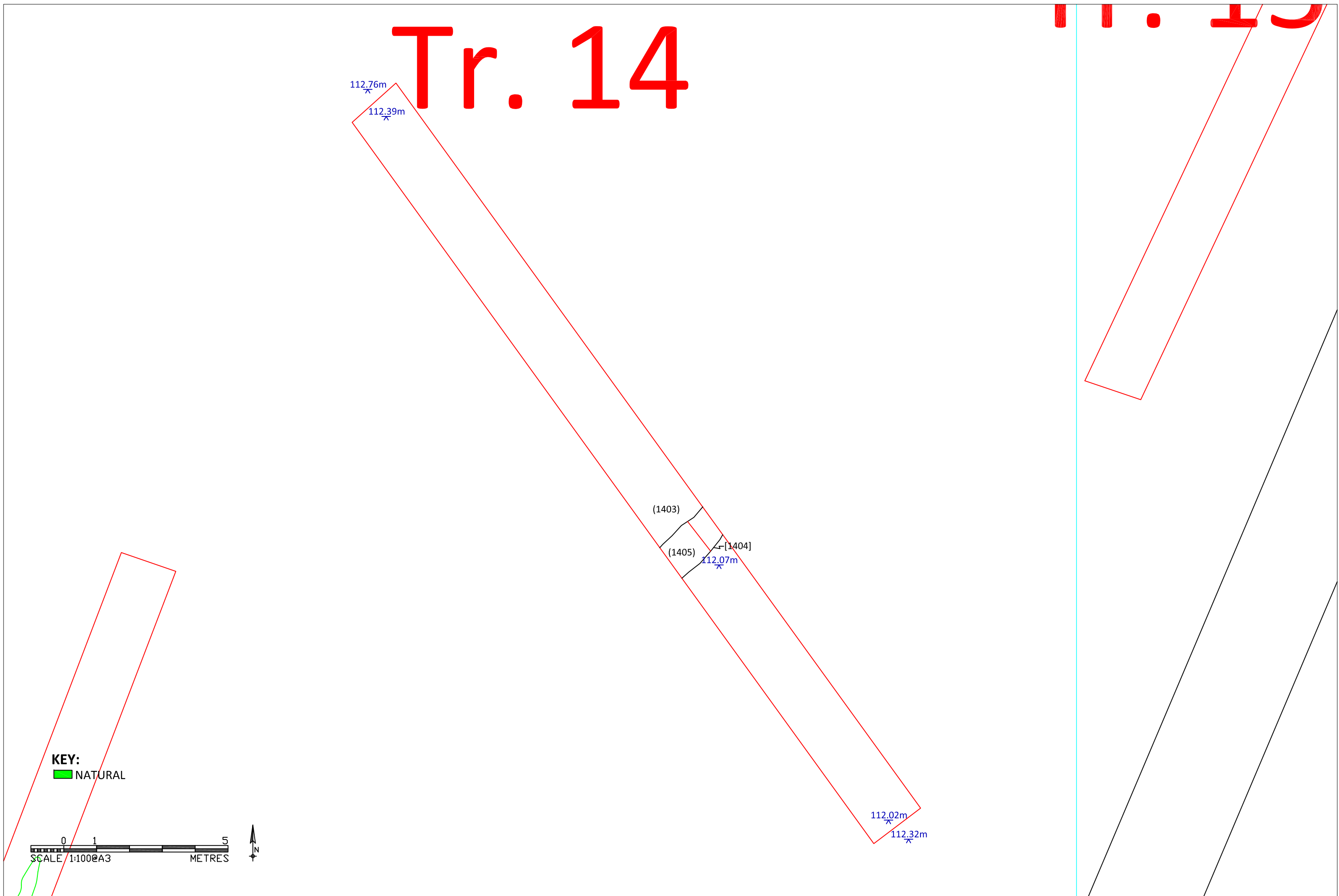

Figure 15: Lenham, Evaluation phase 1 - Trench 14

Tr. 21

110.51m
110.09m

Footpath

110.12m

109.7m

108.98m
(2105)

109.9m
(2104)

[2103]

110.08m

110.04m

109.72m



Figure 16: Lenham, Evaluation phase 1 - Trench 21

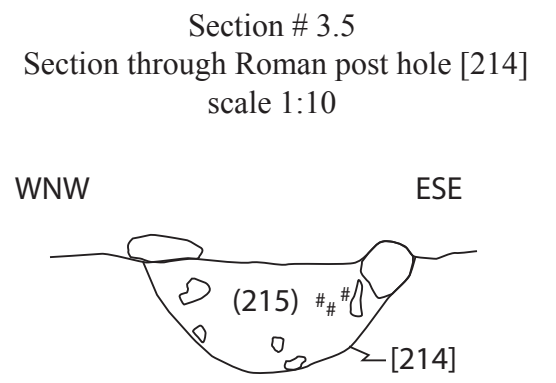
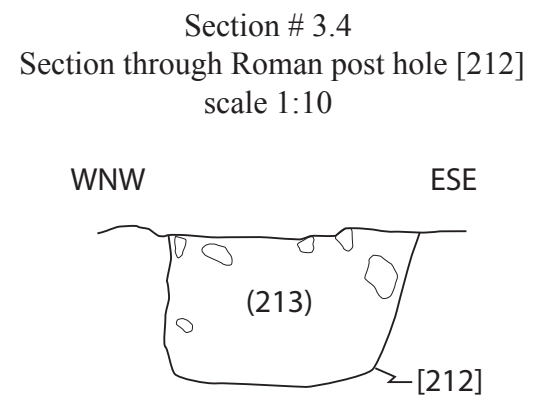
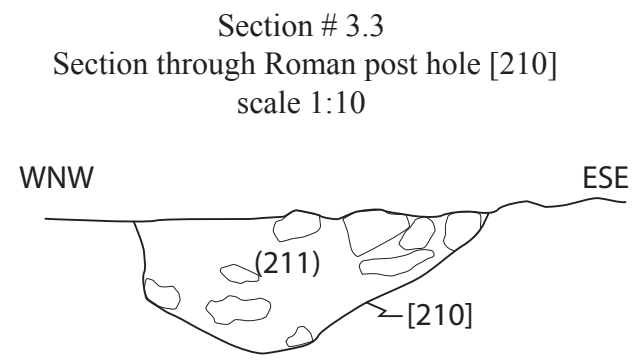
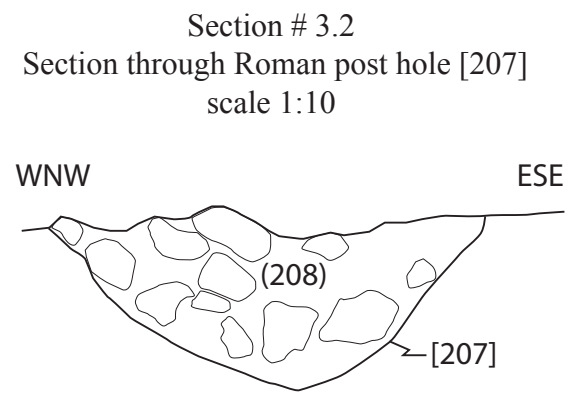
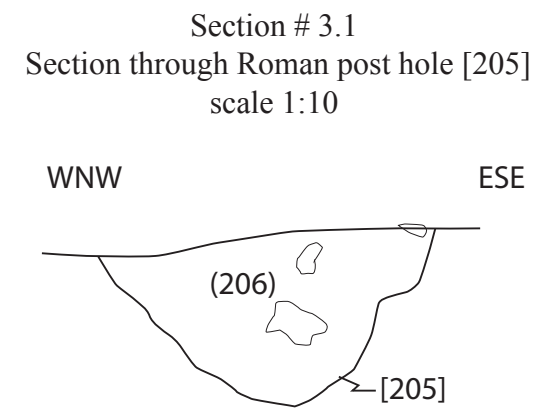
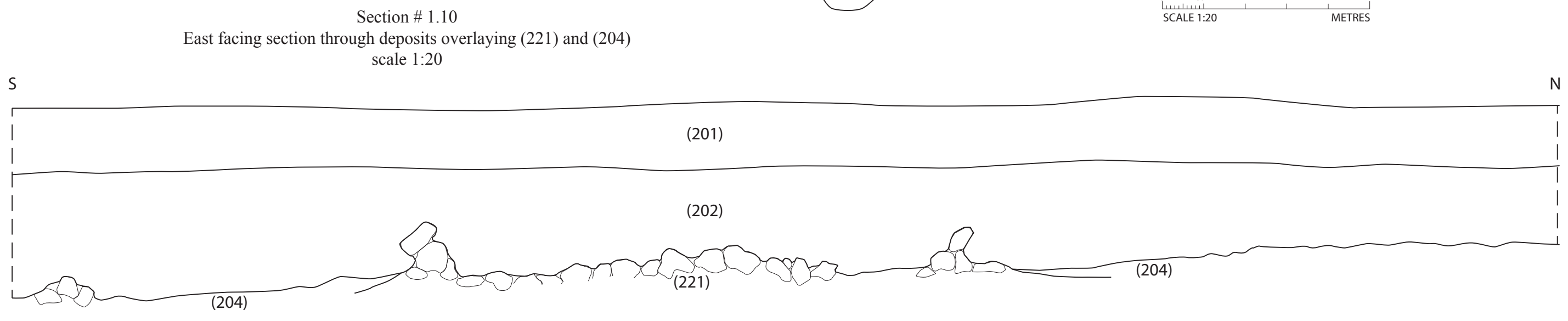
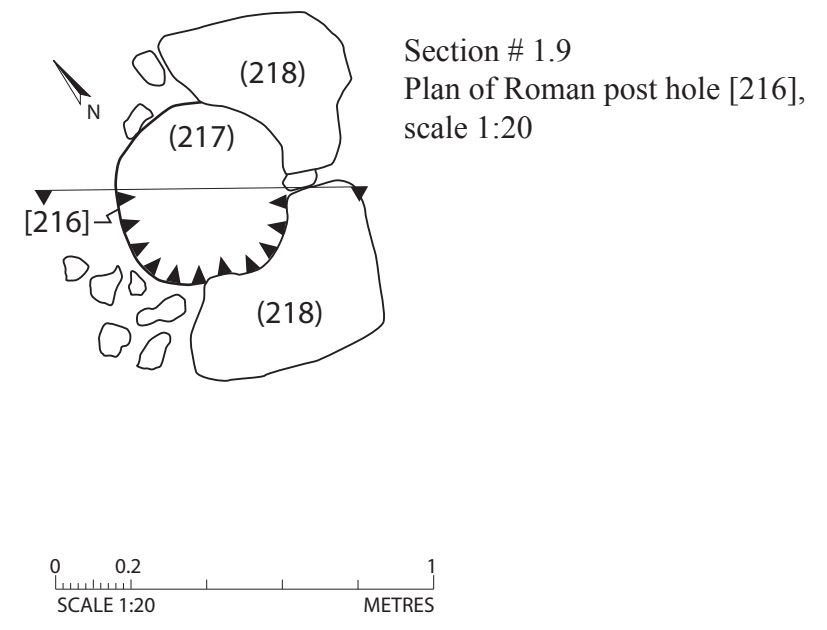
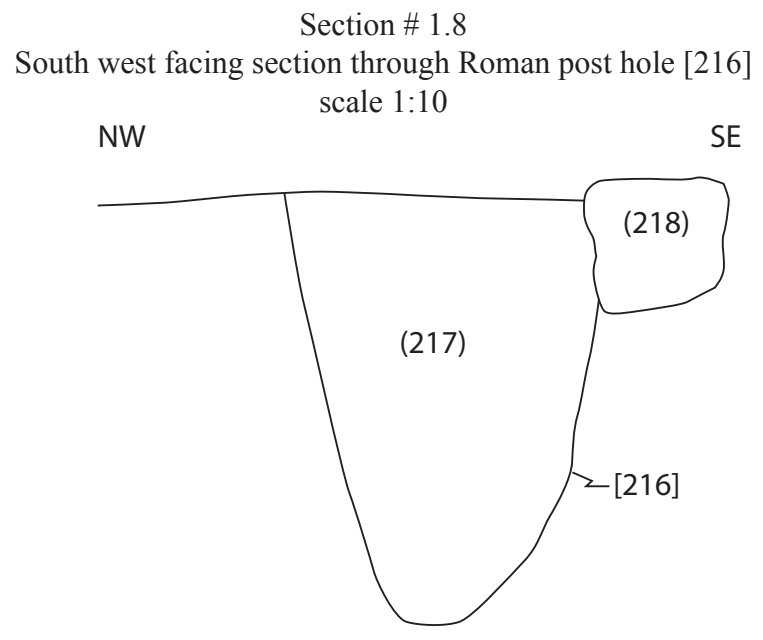
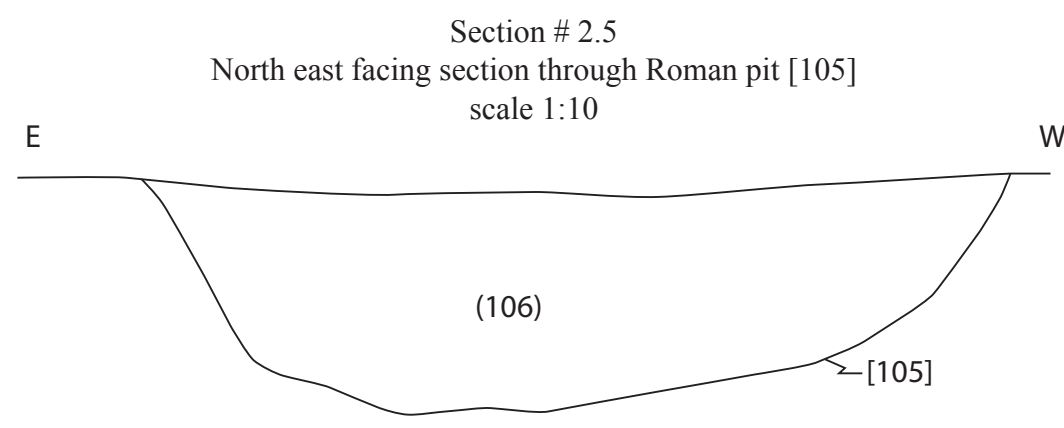

Figure 17: Feature drawings

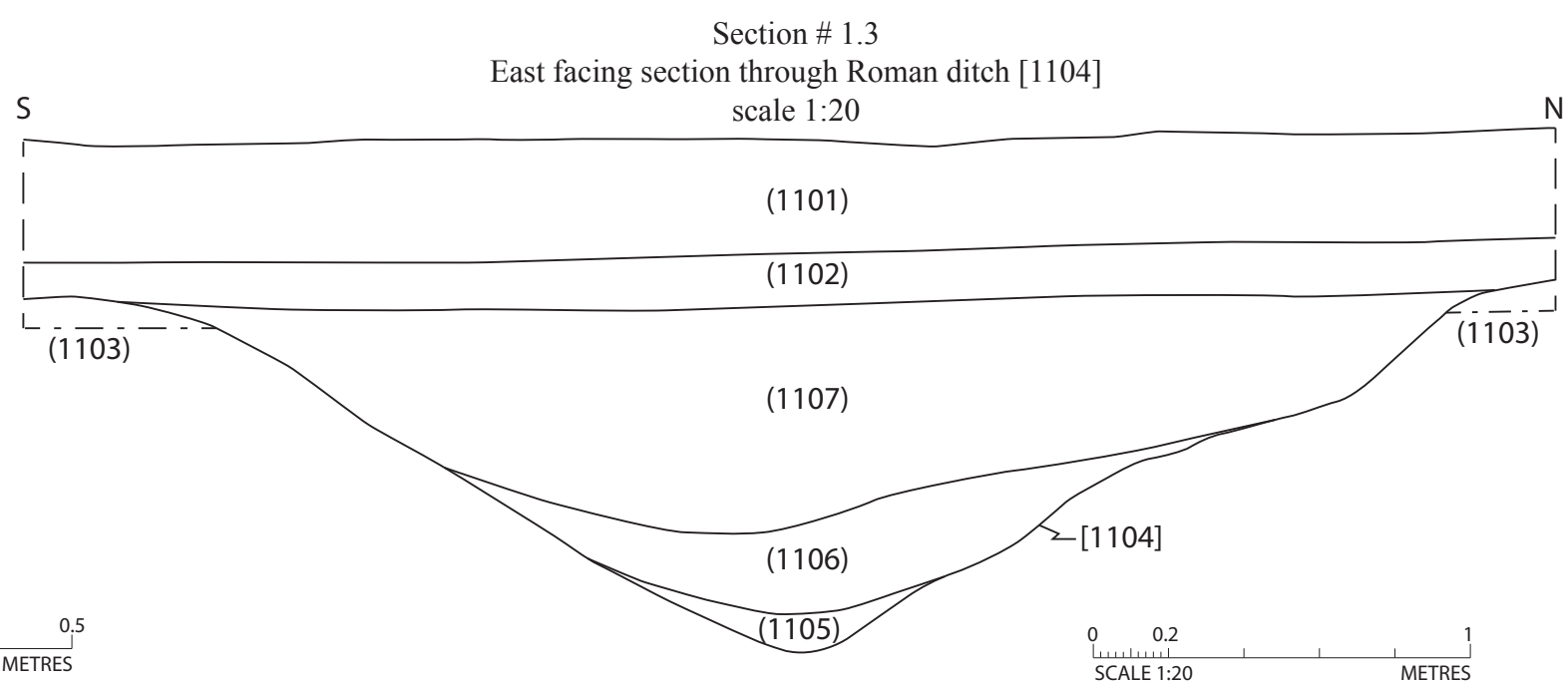
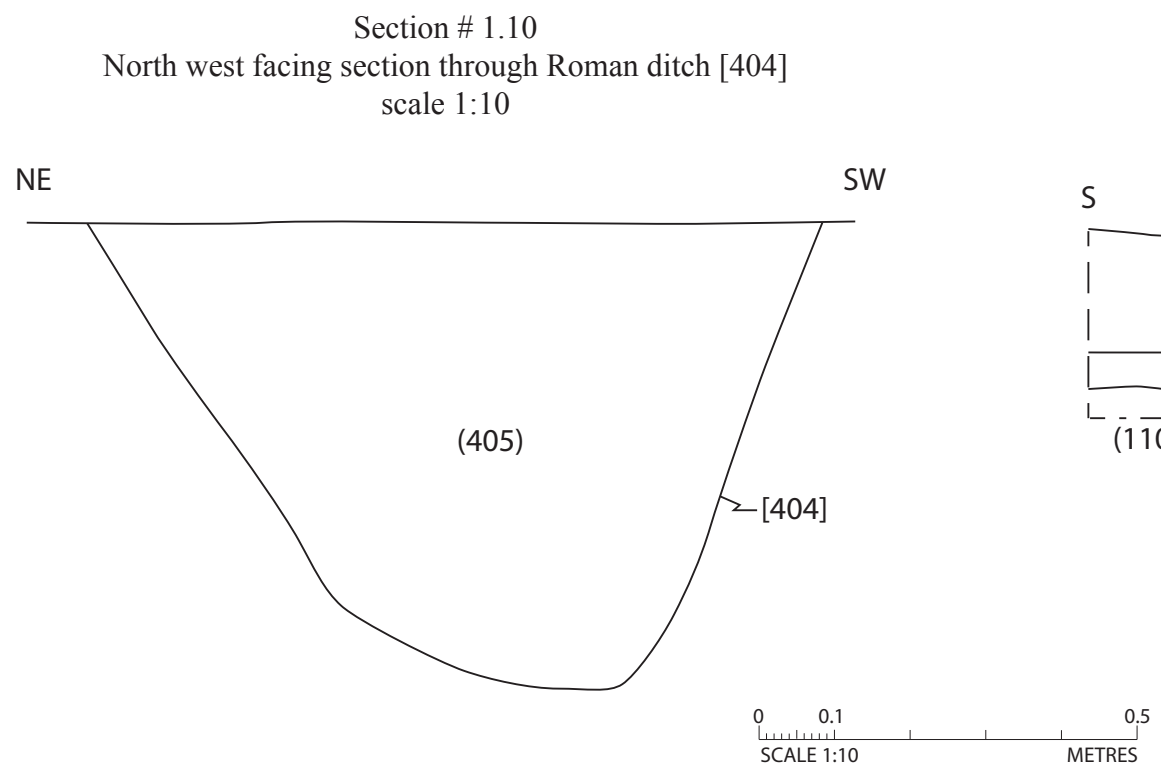
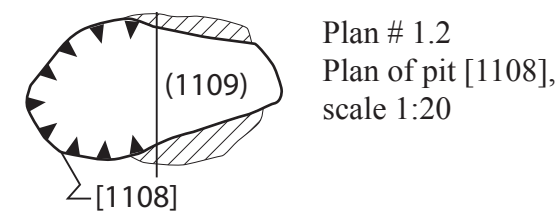
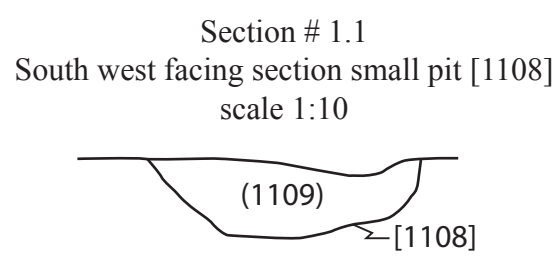
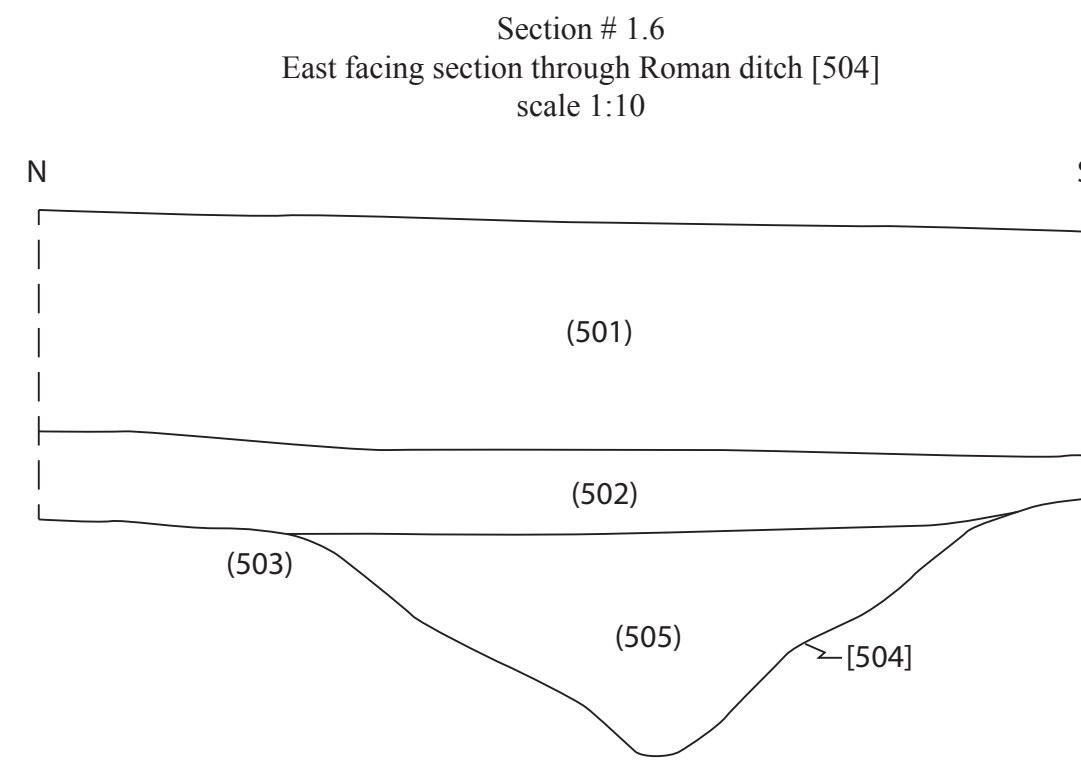
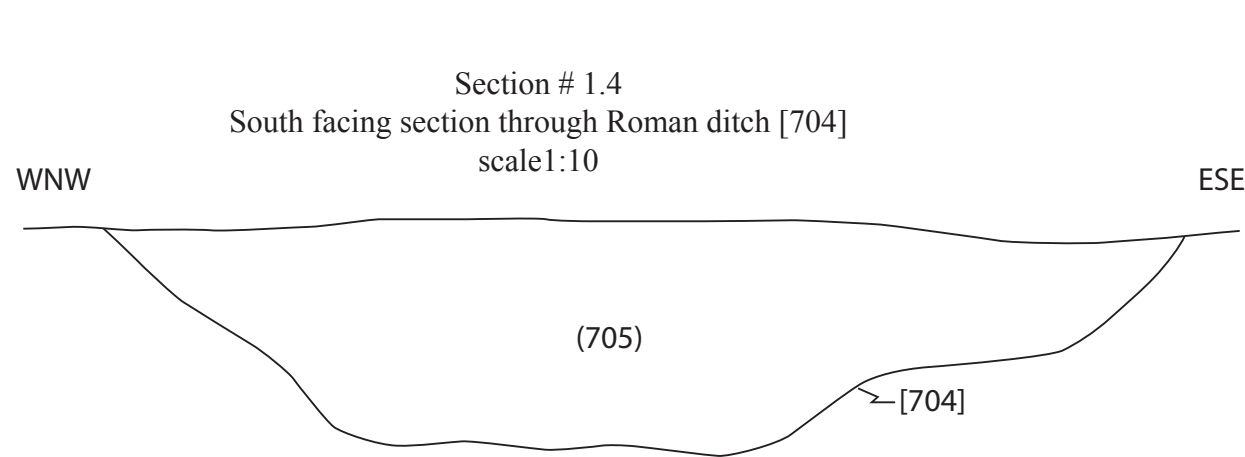
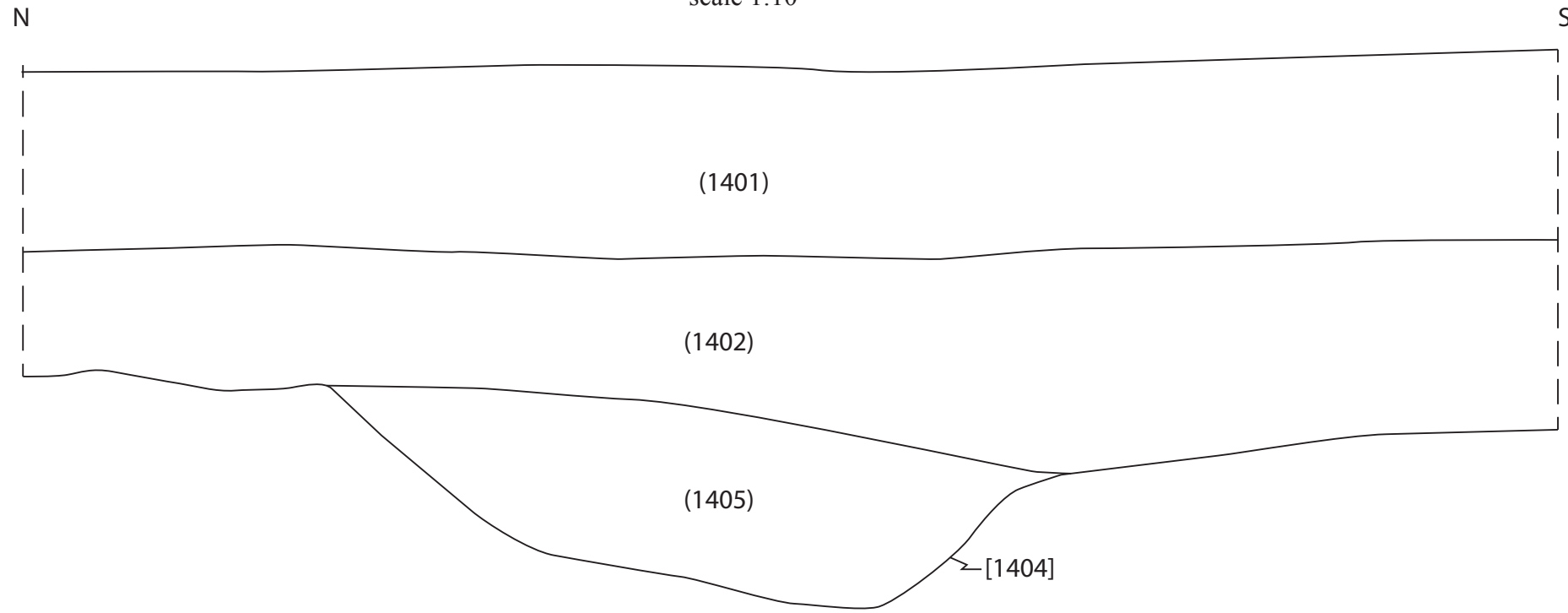
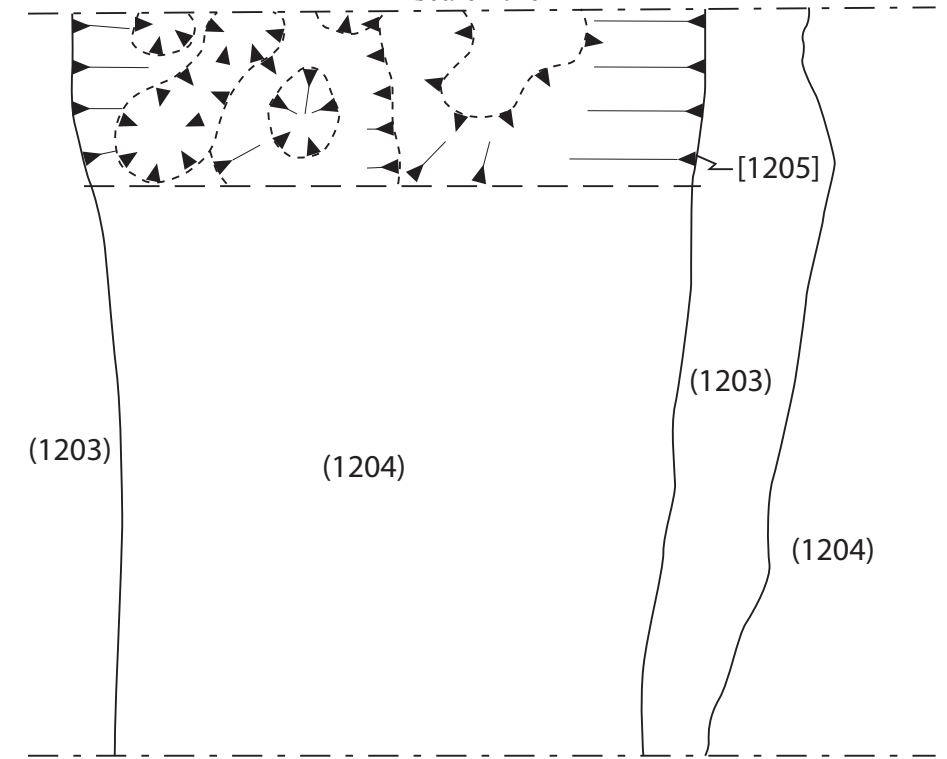

Figure 18: Feature drawings

Section # 2.1
West facing section through Roman ditch [1104]
scale 1:10



Section # 2.4
Plan of geological feature [1205]
scale 1:20



Section # 2.3
Section of geological feature [1205]
scale 1:10

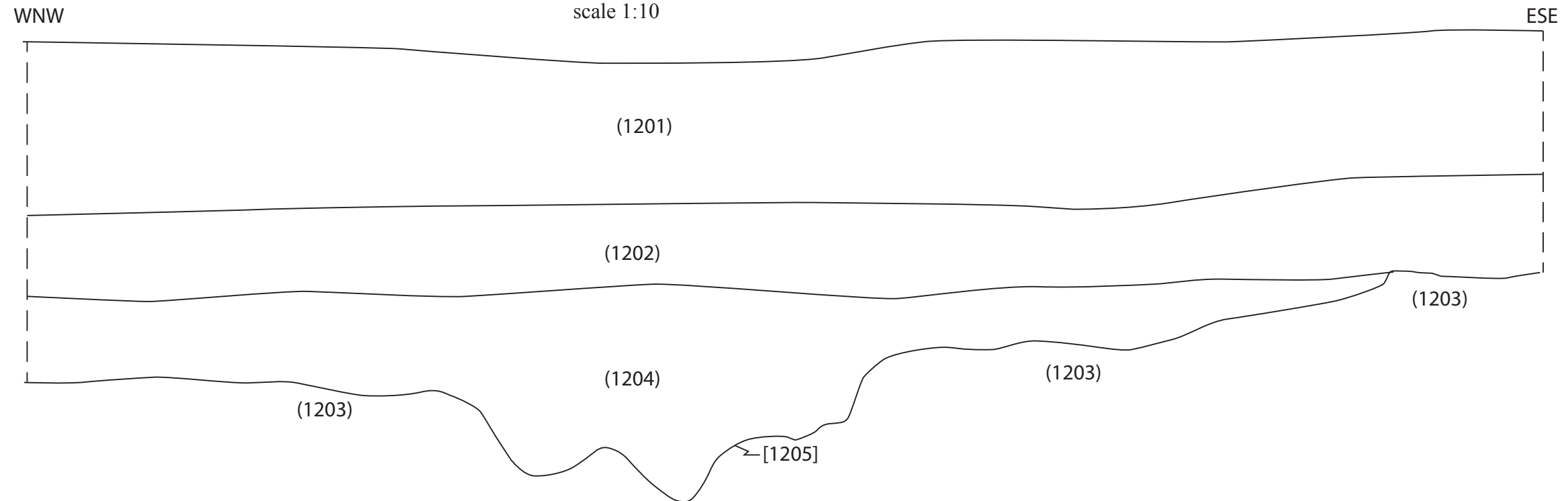

Figure 19: Feature drawings

PLATES



Plate 1: Looking north east at the site from south east corner



Plate 2: Looking west north- west at Trench 1



Plate 3: Looking South at section of Trench 1. Modern trench is visible under right end of 2m scale. To the left test pit dug to bedrock level.



Plate 4: Looking east-south-east at Roman pit [105]



Plate 5: Looking south-south-west at section through Roman pit [105]



Plate 6: Looking north-north-east at Trench 2



Plate 7: Looking east-south-east at extension B of Trench 2. At the end of trench a backfilled test pit is visible.



Plate 8: Looking west at extension C of Trench 2.



Plate 9: Looking north at edge of Roman layer (204) exposed in test pit located at east end of extension C of Trench 2



Plate 10: Looking west at section through edge of Roman layer (204) exposed in test pit



Plate 11: Looking north-north-east at section of extension B of Trench 2



Plate 12: Looking north-north-east at floor (219)



Plate 13: Looking east at section of post hole [216] and post pack boulders (218)



Plate 14: Looking west-north-west at section of trench 2 through deposits overlaying floor (219)



Plate 15: Looking east at post hole [205] prior excavation.



Plate 16: Looking north east at section through post hole [205]



Plate 17: Looking north-north-east at section through post hole [207]



Plate 18: Looking north east at section through post hole [212]



Plate 19: Looking north east at section through post hole [214].



Plate 20: Looking north-east at row of post holes [214, 212, 207, 205]



Plate 21: Looking south west at row of post holes exposed in Trench 2



Plate 22: Looking north east at stone deposit (224)



Plate 23: Looking south west at stone deposit (209)



Plate 24: Looking north- north- east at stone deposit (222)



Plate 25: Looking west-north-west at Roman trample layer (223) located to the south from context (222). Visible here extension A of Trench 2 with backfilled test pit at trench end indicating extend of the context (223).



Plate 26: Looking north-north-east at stone deposit (220)



Plate 27: Looking west-north-west at section of trench 2 through deposits overlaying stone bank (221)



Plate 28: Looking west-north-west at section of northern end of Trench 2. Visible here top soil, sub soil and natural.



Plate 29: Looking west-north-west at Trench 3 with bedrock and orange-brown silty clay exposed.



Plate 30: Looking east-south-east at trench 4. Edge of SE-NW Roman ditch is visible in bottom right trench corner, another parallel Roman ditch is located underneath two metres scale.



Plate 31: Looking south east at section through Roman ditch [404] exposed in trench 4. Above the section a darker fill of Roman ditch, is visible running NE-SW across the trench



Plate 32: Looking south east at section through Roman ditch [404]



Plate 33: Looking north-north-east at Trench 5. Undulating chalk bedrock and per glacial deposit exposed at the bottom of the trench



Plate 34: Looking north east at section through Trench 5 showing drop of level of chalk bedrock



Plate 35: Looking east-south-east at section through Roman ditch [504]



Plate 36: Looking east-south-east at Trench 6



Plate 37: Looking north-north-east at section of Trench 6. Bright linear visible under right end of two metre scale is a modern service trench also exposed in Trench 1.



Plate 38: Looking north-north-east at trench 7 with Roman ditch exposed



Plate 39: Looking north-north-east section through Roman ditch [704].



Plate 40: Looking west-north-west at section of Trench 7 through top soil, sub soil and top of chalk bedrock.



Plate 41: Looking north-north-east at trench 8:



Plate 42: Looking east-south-east at section of Trench 8



Plate 43: Looking north-north-east at Roman ditch [1004]



Plate 43: Looking south west at Roman ditch [1104]



Plate 45: Ditch [1104] viewed from the south



Plate46: Looking north-north-east at small fire pit [1108]



Plate 47: Ditch [1204] viewed from the south



Plate 48: Looking north-east at section through Roman ditch [1404]